

PART 1 GENERAL ORGANISATION OF CYCLING AS A SPORT

Version on 08.02.2018

TABLE OF CONTENTS

	Page
Chapter I LICENCE-HOLDERS.....	3
§ 1 Licences	3
§ 2 Categories of riders.....	12
§ 3 Teams.....	14
§ 4 Commissaires.....	15
§ 5 Sports directors.....	20
§ 6 Technical delegate.....	22
Chapter II RACES.....	23
Section 1: administrative provisions	23
§ 1 Calendar	23
§ 2 Names of races.....	26
§ 3 Forbidden races.....	26
§ 4 Access to a race	26
§ 5 Sanction.....	27
§ 6 Classifications and cups	27
§ 7 National Championships	27
§ 8 Betting	28
§ 9 Sponsoring	28
Section 2: organisation of races	30
§ 1 Organiser	30
§ 2 Authorisation to organise the event.....	30
§ 3 Specific regulations.....	31
§ 4 Programme - technical guide	31
§ 5 Invitation – Enrolment	32
§ 6 Race headquarters – Secretarial office	34
§ 7 Course and safety.....	34
§ 8 Medical service	35
§ 9 Prizes	36
§ 10 Travel and subsistence expenses	36
Section 3: race procedures.....	38
§ 1 Supervision of the organisation and competition	38
§ 2 Conduct of participants in cycling races	38
§ 3 Team manager	38
§ 4 Team managers' meeting	39
§ 5 Entry check.....	39
§ 6 Start of the race	40
§ 7 Finish.....	40
§ 8 Awards ceremony	42
Section 4: supervision of races.....	44
§ 1 General provision.....	44
§ 2 Commissaires' panel.....	44
§ 3 Powers of the commissaires' panel.....	55
Section 5: UCI cups, series and classification	57

Chapter III EQUIPMENT	58
Section 1: general provisions	58
§ 1 Principles	58
§ 2 Technical innovations	59
Section 2: bicycles.....	60
§ 1 Principles	60
§ 2 Technical specifications	61
Section 3: riders' clothing	72
§ 1 General provisions.....	72
§ 2 Teams registered with the UCI.....	73
§ 3 Regional and club teams	74
§ 4 Leaders' clothing.....	75
§ 5 National team clothing	76
§ 6 World champion's jersey	78
§ 7 National champion's jersey	80
§ 8 Continental champion's jersey	81
§ 9 Order of priority.....	81
§ 10 Sanctions.....	81
Section 4: identification of riders.....	83

PART 1 GENERAL ORGANISATION OF CYCLING AS A SPORT

Chapter I LICENCE-HOLDERS

§ 1 Licences

Definition

- 1.1.001** The licence is an identity document confirming that its holder undertakes to respect the constitution and regulations and which authorise him to participate in cycling events.

Principles

- 1.1.002** No-one who does not hold the requisite licence may participate in a cycling event organised or supervised by the UCI, the UCI continental confederations, the UCI member federations or their affiliates.

Participation by a person who does not hold the required licence shall be null and void, without prejudice to other penalties.

(text modified on 1.01.05).

- 1.1.003** The licence must be presented whenever requested by a duly authorised person.

- 1.1.004** Anyone requesting a licence thereby undertakes to respect the constitution and regulations of the UCI, the UCI continental confederations and the UCI member Federations, as well as to participate in cycling events in a sporting and fair manner. He shall undertake, in particular, to respect the obligations referred to in article 1.1.023.

As from the time of application for a licence and provided that the licence is issued, the applicant is responsible for any breach of the regulations that he commits and is subject to the jurisdiction of the disciplinary bodies.

Licence holders remain subject to the jurisdiction of the relevant disciplinary bodies for acts committed while applying for or while holding a licence, even if proceedings are started or continue after they cease to hold a licence.

(text modified on 1.01.04; 15.10.04).

- 1.1.005** The licence shall be issued and used under the exclusive responsibility of its holder or his legal representative.

The granting of the licence shall not imply that the issuing authority recognises or assumes any responsibility as to the aptitude of its holder, or for his compliance with the conditions of any law, statute or regulation.

- 1.1.006** 1. Federations shall issue licences according to such criteria as they may determine. They shall be responsible for monitoring compliance with these criteria.

Before the licence is issued, the licence holder and the national federation must ensure inter alia that the licence holder is adequately insured against accidents and civil

responsibility in every country where he practices competitive cycle sport or training throughout the year for which the licence is issued.

2a. Riders susceptible of taking part in events on the international calendar as well as national championships must be given a UCI ID which will appear on their licence. The national federation is responsible for ensuring that all riders susceptible of taking part in the aforementioned events are given a UCI ID.

The UCI ID is provided by the UCI to the national federation at the time of the first relevant licence application by the rider and shall appear on any licence he may hold, regardless of the category or the national federation issuing the licence.

2b. All other riders may be given a UCI ID or may be given an identification number determined by the national federation, at the national federation's discretion.

3. All other licence holders in accordance with clause 1.1.010 below shall be given a UCI ID which will appear on their licence.

The UCI ID is provided by the UCI to the national federation at the time of the first licence application and shall appear on any licence the person concerned may hold, regardless of the category or the national federation issuing the licence.

(text modified on 15.10.04; 1.07.11; 1.10.11; 1.01.17).

1.1.006 bis No licence to participate in the sport as Staff under clause 1.1.010 (general manager, team manager, coach, doctor, paramedical assistant, mechanic, driver, riders' agent or other function as specified on the licence) shall be granted to a person who has been found by an appropriate body to have violated as an athlete the UCI's Anti-Doping Rules or the anti-doping rules of any other organisation.

However, a licence may be granted if all three of the following conditions are fulfilled:
(1) the person concerned committed a violation only once,
(2) the said violation was not sanctioned with an ineligibility for two years or more,
(3) five years have elapsed between the moment of the violation and the first day of the year for which the licence is granted.

Furthermore, no licence to participate in the sport as a staff member under clause 1.1.010 shall be granted to a person who has been found by a court of law or other competent body to have been guilty of facts which can reasonably be considered to be equivalent to a violation of the UCI's Anti-Doping Rules and who was a medical doctor at the time of such facts.

This clause applies in case of violations committed as from 1st July 2011.

(text modified on 15.10.04; 1.07.11; 1.10.11; 1.01.17).

1.1.007 Federations may make the issue of the licence subject to the payment of a licence fee, the amount of which they shall determine.

1.1.008 The licence shall be valid for one year, from 1 January to 31 December. It shall be valid in all countries where there is a UCI member national federation.

1.1.009 A licence holder may hold the licence of only one national federation.

Categories of licence holders

- 1.1.010** A licence shall be required for:
- 1.1 A rider (man or woman, all disciplines, all categories)
 - 1.2 A participant in cycling for all
 - 1.3 A pacer
A motor-cycle-mounted pacer (motorcycle, moped, derny)
 - 1.4 Rider's agent
 - 1.5 Staff
 1. general manager
 2. team manager
 3. coach
 4. doctor
 5. paramedical assistant
 6. mechanic
 7. driver
 8. other function to be specified on the licence.
 - 1.6 Officials
 1. federation administrator (status to be specified on the licence)
 2. commissaire (status to be specified on the licence)
 3. para-cycling classifier (status to be specified on the licence)
 4. other role (e.g. timing/photo-finish operator, announcer, race radio operator, etc.) to be specified on the licence.
 - 1.7 Organiser
 1. organisational administrator
 2. other function to be specified on the licence.
 - 1.8 Other
 1. Vehicle driver (car, motorbike, etc.) in a road event.

Should a licence holder carry out multiple roles within cycling, he must apply and be licensed for each of these roles. It shall be the responsibility of the national federation to issue the licence corresponding to the primary role as per the order set out above. In addition to the licence, the national federation shall issue a certificate setting out the other roles for which the licence holder is recognised.

A rider belonging to a team registered with the UCI may not carry out another role.

(text modified on 1.01.00; 15.10.04; 25.06.07; 1.07.11; 1.01.13).

Issuing procedure

- 1.1.011** The licence shall be issued by the federation of the country where, according to the legislation of that country, the applicant has his main residence at the time of application. He shall remain affiliated to that federation until the expiry of the licence, even if he changes country of residence.
- 1.1.012** National federations shall refuse to issue a licence in the event of an irregular application.
- 1.1.013** In the case of a country where there is no UCI member federation, the licence shall be issued by the UCI.
- 1.1.014** If a national federation does not respond to a licence application within 30 days of its being filed, the applicant may lodge his licence application with the UCI.
- 1.1.015** If the UCI or a federation deems that it cannot issue the requested licence, it shall inform the applicant to that effect stating its reasons by registered letter with recorded delivery.

Similarly, the applicant shall be invited to defend his application, as appropriate, before such person or commission as may be designated by the president of the UCI or as indicated in the regulations of the federation or, where the regulations contain no such mention, by its president.

The applicant shall be entitled to consult his file. He shall be entitled to present his argument and to enlist the assistance of or be represented by any person of his choice bearing a proper power-of-attorney.

1.1.016 The applicant shall be informed of both the refusal to issue the licence and of the reasons for the refusal by registered letter with recorded delivery.

1.1.017 A refusal to issue a licence shall be open to appeal before the UCI arbitral board in following cases:

- the applicant has had no opportunity to present his arguments;
- no reason was given for the decision;
- the reasons for the refusal contain factual errors;
- the refusal is irregular.

The appeal shall be lodged within 30 days of reception by the applicant of the notification of refusal.

The decision of the arbitral board is final and not subject to appeal.

(text modified on 1.01.10).

1.1.018 A national federation may bring an appeal, before the UCI arbitral board, against the issuing of a licence by another federation if the issuing federation did not have territorial jurisdiction or if the licence was irregularly issued.

This appeal shall be lodged within 15 days of the federation being informed about the issue of the licence, but at the latest within three months of the licence being issued. The decision of the arbitral board is final and not subject to appeal.

(text modified on 1.01.00; 1.01.10).

1.1.019 The issuing of a licence by the UCI shall be subject to the payment of an amount set annually by the management committee. To that amount shall be added such insurance premium as the UCI deems proper to take out for the rider.

1.1.020 Any member federation of which a licence holder possesses the nationality shall be informed within one month of the licence holder's application and the issuing of the licence in the following cases:

- a) if the applicant does not hold the nationality of the federation to which he applied;
- b) if the applicant holds the nationality of the federation to which he applied but also of one or more other national federations;
- c) if the licence application is made to the UCI.

(text modified on 1.01.00).

Licence

1.1.021 The licence application shall be made on a form to be prepared by each federation. **The content of such form shall be accepted by the applicant, regardless of the form of presentation (electronic or paper).** The form must at least include the information and the undertakings stated in the following model:

(text modified on 1.01.18)

**1.1.022 Front (Part I)
UNION CYCLISTE INTERNATIONALE
NAME OF THE NATIONAL FEDERATION**

1. Category for which the licence is requested UCI: national:
2. Surname and first name:
3. Date of birth:
4. Nationality:
5. Gender:
6. **Email address:**
- 6a. UCI ID (current and past holders of UCI ID):
- 6b. UCI ID required (not yet holder of UCI ID but necessary for following season):
yes/no
7. Place and address of main residence at the time of application:
8. Place and country of the previous main residence if changed in the last year:
9. Countries in which the applicant has other residences:
10. Authority (federation or UCI) that issued the applicant's previous licence:
11. Authority (federation or UCI) that has refused to issue a licence during the past three years:
12. Applicant's club:
13. Applicant's UCI team (name and type):
14. If the applicant is currently suspended and will continue to be for all or part of the year of validity of the licence, the name of the authority that imposed the suspension and the starting and ending dates of the suspension:
15. Insurance for bodily injury (in and out-patient hospital expenses and medical care, transport costs, permanent disablement, death) and material damages (loss of earnings) in case of accident on the occasion of a cycling competition or event or during training:
 - name and address of the insurance company:
 - name and address of the insured party:
 - duration of validity of the insurance policy,
 - amount of cover guaranteed
 - territorial validity.
16. Third-party liability insurance for material damage or bodily injury caused to others in the course of a competition or cycling event or during training:
 - name and address of the insurance company:
 - name and address of the insured party:
 - duration of validity of the insurance policy,
 - amount of cover guaranteed
 - territorial validity.

(text modified on 15.10.04; 1.01.17; 1.01.18).

1.1.023 Back (Part II)
1. I hereby declare that I am aware of no reason why I should not be granted the requested licence.

I undertake to spontaneously return my licence in the event of any substantial change to the circumstances existing at the time of the application for a licence.

I declare that I have not applied for a licence for the same year to the UCI or to any other national federation.

I assume exclusive liability for this application and for the use that I shall make of the licence.

2. I hereby undertake to respect the constitution and regulations of the UCI, its continental confederations and its national federations.

I declare that I have read or have had the opportunity to become acquainted with the aforesaid constitution and regulations.

I acknowledge and agree that my personal information provided as part of my application shall be passed and held by the UCI.

I shall participate in cycling competitions or events in a sporting and fair manner.

I shall **comply with all decisions rendered by the UCI** and shall take any appeals and litigation before the authorities provided for in the regulations.

I accept the Court of Arbitration for Sport (CAS) as the sole competent **authority** for appeals **as provided in the UCI Regulations** and under the conditions set out in these regulations, **and for the rest, by the CAS Code of Arbitration for Sport**.

I agree that any litigation with the UCI shall solely be submitted to the Court of Arbitration for Sport (CAS).

3. **I agree to abide and be bound by the UCI Anti-Doping Rules, as well as all documents adopted by the UCI in connection with its Anti-Doping Rules and in connection with the World Anti-Doping Code.**

I agree to submit to in-competition and out-of-competition testing at any time as provided in the UCI Anti-Doping Rules and related documents. I agree that all samples collected from me under the UCI Anti-Doping Rules are owned by the UCI and that such ownership may be transferred by the UCI to another Anti-Doping Organisation, or ownership transferred from another Anti-Doping Organisation to the UCI.

Applications submitted by paper shall be dated and signed by the applicant.

Electronic application systems shall include as a condition to proceed the full acceptance of the above-mentioned terms as well as a traceable report of the details of the application.

(text modified on 1.01.00; 13.08.04; 15.10.04; 1.01.17; 1.01.18).

Form of licence

1.1.024 The licence shall be in the form of a credit card.
It shall include the following data:

On the front

UNION CYCLISTE INTERNATIONAL NAME OF THE NATIONAL FEDERATION		
UCI Category:	UCI ID:	YEAR
National Category:	National federation number:	
Surname:	Date of birth:	
First name:	Address:	
Nationality:	Gender: H / F	
Team:		
Club:		
Issued on:		

On the back

UNION CYCLISTE INTERNATIONAL NAME OF THE NATIONAL FEDERATION	
Should the photograph not be required, the holder must always be able to present his licence together with another ID document bearing his photo.	I agree to abide and be bound by the UCI Constitution and Regulations, in particular the UCI Anti-Doping Rules. I also recognise the exclusive jurisdiction of the Court of Arbitration for Sport (CAS) in Lausanne, Switzerland, as provided for under the relevant provisions of the UCI Regulations.

Electronic licence application systems shall (i) include as a condition to proceed the full acceptance of the terms contained on the licence and (ii) provide a traceable report of the details of the application.

(text modified on 6.10.97; 1.01.04; 13.08.04; 15.10.04; 1.01.17; 1.01.18).

1.1.025 The licence shall be written in French or English. Other language versions of its text may also appear.

The licence shall be signed by the president of the national federation that issued it or by the president of the UCI and by the holder. The holder shall sign under the declaration which reads "I agree to abide and be bound by the UCI Constitution and Regulations, in particular the UCI Anti-Doping Rules. I also recognise the exclusive jurisdiction of the Court of Arbitration for Sport (CAS) in Lausanne, Switzerland, as provided for under the relevant provisions of the UCI Regulations."

(text modified on 6.10.97; 15.10.04; 1.01.18).

1.1.027 (N) The national federation shall determine whether the photograph of the holder has to appear on the licence. Should the photograph not be required, the holder must always be able to present his licence together with another ID document bearing his photo.

1.1.028 The colour of the licence shall differ from year to year in the order given hereafter:
2015: red
2016: green
2017: white
2018: yellow
2019: blue
2020: red
etc.

A federation may choose not to issue licenses following the color scheme above. In such a case the year of the license must figure prominently on the front and back of the license.

(text modified on 1.01.04; 15.10.04; 1.10.10; 1.01.16; 8.2.18).

1.1.028 bis Each National Federation shall inform the UCI within one week of the identity of the licence-holders whose licence was withdrawn, who returned their licence or who did not renew their licence.

(article introduced on 1.01.09).

Penalties

1.1.029 The following infringements shall be penalised as indicated below:

- 1) participation or attempt to participate, in a cycling competition or event without holding the requisite licence:
 - start refused
 - and
 - a waiting period of one year before obtaining a licence.
- 2) participation or attempt to participate, in a cycling competition or event without carrying the licence:
 - start refused or disqualification
 - And
 - fine of CHF 50 to 100.

(text modified on 15.10.04; 1.01.18).

Sundry provisions

1.1.030 National federations may permit, under such conditions as they may determine, persons who take part in cycling events only occasionally to take part in a particular event at national level without holding a licence valid for a whole year. These conditions must include agreement to abide by the regulations of the UCI and the national federation and suitable insurance for the whole day or all days of the event.

(text modified on 1.01.05).

1.1.031 Articles 1.1.011 to 1.1.029 shall not apply to riders in the youth category, such matters being governed by the national federations.

1.1.032 A licence holder whose licence is withdrawn because of a suspension the effect of which is limited to the territory of his national federation, may obtain a provisional authorisation from the UCI which is valid in all other UCI member countries. Such a provisional authorisation shall in all other respects be subject to the rules governing the licence.

1.1.033 A. For the world championships, continental championships and for teams participating in UCI world cup events, a rider may only be selected by the federation of his nationality, regardless of the federation that issued his licence. A rider shall be subject to the regulations and disciplinary procedures of the national federation of his nationality in all matters concerning his selection for the national team.

A stateless rider may be selected only by the national federation of a country where he has been continuously in residence for at least five years.

B. A rider holding multiple nationalities shall be required to choose between them on the occasion of first applying for a licence. The nationality chosen will then be the rider's nationality for all matters regarding the UCI regulations.

The first application for a licence permanently defines a rider's nationality for the whole of his career, except in the following cases:

- a. if the nationality in question is lost for any reason, and without prejudice to paragraph b, the rider may choose one of the nationalities to which he is entitled in accordance with his civil status;
- b. if the rider was a minor at the time of first applying for a licence in accordance with the relevant laws of each of the nations in question, the rider may choose a different nationality – to which he is entitled in accordance with his civil status – when making a first application for a licence after he reaches the age of majority, in accordance with the laws of each of the nations in question;
- c. if a rider acquires an additional nationality, the rider may choose this nationality. This choice must be made, at the latest, when applying for a licence for the second year following the year of acquisition of the new nationality. This choice is final unless the rider loses the nationality in question (B.a.) or if a global agreement intervenes (B.d.);
- d. in exceptional cases and in the event of the agreement of the national federations concerned (the nations in question) and the UCI, a rider may choose another nationality to which he is eligible in accordance with his civil status, even if he had already made an initial choice that had been considered final in principle. A change of this kind is only allowed once in a rider's career;
- e. in the cases described in B.c. and d and insofar as the rider has already represented the former nationality in the events described in A., a rider who has validly chosen a new nationality may not be selected nor participate in:
 - i. the world championships held in the year in which the rider's change of nationality is approved by the UCI;
 - ii. the world championships held in the year after the change of nationality.

Example: a rider holding nationality A acquires nationality B on 1 July 2013 and wishes to henceforth represent nation B. The change of nationality is approved by the UCI on 5 October 2013. The rider may not represent nation B at the world championships of 2013 (i) or 2014 (ii). However, the rider may immediately represent nation B at other competitions, in particular continental championships and as a member of the national team for world cup events. A rider who has never represented nation A at the world championships, continental championships or as a member of the national team

competing in world cup events, shall not be subject to any restrictions and may immediately represent nation B at the world championships.

The rider must send the UCI Legal Services the following documents in order to formalise his choice of nationality:

- Proof of eligibility for the nationality chosen, which may be illustrated by a certificate issued by a competent authority (ministry, consulate, embassy, etc.) attesting to the date of acquisition of the nationality.
- A formal statement by the rider, signed and dated, expressing the choice of nationality and the fact that the rider is aware that this choice is final for his entire career in accordance with UCI regulations.

C. A rider who changes nationality may not be selected to participate in the world championships held in the year in which the change was approved by the UCI, nor in the world championships of the year following the change of nationality.

Comment: a change of nationality means that a person of nationality A loses this nationality upon acquiring nationality B. There is thus no need to make a choice of nationality as described in B.c.

The rider must send the UCI Legal Services the following documents in order to formalise his change of nationality:

- Proof of acquisition of the new nationality, which may be illustrated by a certificate issued by a competent authority (ministry, consulate, embassy, etc.) attesting to the date of acquisition of the nationality.
- A formal statement by the rider, signed and dated, expressing the new nationality and acknowledging the fact that the rider is aware that this change is final for his entire career in accordance with UCI regulations.

D. Participation in national championships is governed by Art. 1.2.028 of these regulations.

E. The determination of a country that a rider can represent at the Olympic and Paralympic Games is governed by the Olympic Charter.

(text modified on 8.06.00; 1.01.04; 1.10.11; 1.05.14).

1.1.033 [article abrogated on 1.05.16]
bis

§ 2 Categories of riders

Competitive cycling

1.1.034 For participation in events on the international calendar, riders' categories are determined by the age of those competing as defined by the difference between the year of the event and the year of birth of the rider.

(text modified on 1.01.05; 1.01.17).

- 1.1.034 bis** For participation in events on the international calendar and national championships, riders shall be required to hold a UCI ID.

(article introduced on 1.01.17).

- 1.1.035** Without prejudice to relevant legal provisions, only riders aged 17 or more to whom a licence for one of the international categories below has been issued shall have the right to take part in events on the international calendar. However, riders aged 16 or under may take part in international BMX events (including BMX Freestyle events) if the applicable legislation does not prohibit it.

(text modified on 1.01.05; 1.01.17).

Men

- 1.1.036 Youth**

This category denotes riders aged 16 years or under and is controlled by national federations, except as provided for BMX in article 1.1.035.

Juniors (MJ: Men Juniors)

This category shall comprise riders aged 17 and 18.

Under 23 (MU: Men Under 23)

This category shall comprise riders aged 19 to 22.

Elite (ME: Men Elite)

This category shall comprise riders aged 23 and above.

Masters (MM: Men Masters)

This category shall comprise riders of 30 years and above who elect this status. The choice of masters status shall not be open to a rider belonging to a team registered with the UCI.

Para-cyclists

This category shall comprise riders with disabilities as specified by the UCI functional classification system described in part 16, chapter V.

A para-cyclist may, or may not for health and safety reasons, be issued with an additional category from the current list, regarding the established integration procedure. This depends on the degree and nature of the disability.

(text modified on 1.01.03; 1.01.04; 1.01.05; 25.06.07; 1.07.13; 1.01.15; 1.03.16).

Women

- 1.1.037 Youth**

This category denotes riders aged 16 years or under and is controlled by national federations, except as provided for BMX in article 1.1.035.

Juniors (WJ: Women Juniors)

This category shall comprise riders of 17 and 18 years old.

Under 23 (WU: Women Under 23)

Unless otherwise provided in the UCI Regulations, this category shall comprise riders aged 19 to 22.

Elite (WE: Women Elite)

This category shall comprise riders aged 23 and above.

Masters (WM: Women Masters)

This category shall comprise riders of 30 years and above who elect this status. The choice of masters status shall not be open to a rider belonging to a team registered with the UCI.

Para-cyclists

This category shall comprise riders with disabilities as specified by the UCI functional classification system described in part 16, chapter V.

A para-cyclist may, or may not for health and safety reasons, be issued with an additional category from the current list, regarding the established integration procedure. This depends on the degree and nature of the disability.

(text modified on 1.01.03; 15.10.04; 25.06.07; 1.07.13; 1.01.17).

1.1.038 Designations may be adapted in national languages according to linguistic constraints.

Cycling for all

1.1.039 A cycling for all licence is issued to the cyclists practising cycling as a leisure activity. This licence shall give access only to events on the cycling for all calendar.

(text modified on 1.01.05).

§ 3 Teams

Definitions

1.1.040 Under these regulations a team is a sports organisation comprising riders and persons supporting them with the aim of taking part in cycling events. Depending on the context the term "team" may also denote the riders of a team who are taking part in a given event.

(article introduced on 1.01.05).

Teams registered with the UCI

1.1.041 The following teams are teams registered with the UCI:

UCI WorldTeam: see articles 2.15.047 et seq.

UCI professional continental team: see articles 2.16.001 et seq. UCI continental team and UCI women's team: see articles 2.17.001 et seq.

UCI mountain-bike team: see articles 4.10.001 et seq.

UCI track team: see articles 3.7.001 et seq.

UCI BMX team: see articles 6.8.001 et seq.

The reference to the UCI in the name of the categories of team above refers only to the fact that the team has been registered with the UCI under the present regulations.

(text modified on 1.01.05; 1.07.10; 1.01.15).

1.1.042 A rider who is part of a team registered with the UCI may not enter into commitments to an organiser, whoever he may be, to take part in an event unless he has obtained prior

consent from his team. That agreement shall be considered to have been granted if, on being duly requested, no answer has been received within ten days.

Any rider in breach of this regulation shall be disqualified and fined from CHF 300 to 5,000.

(article introduced on 1.01.05).

- 1.1.043** A rider whose team is entered in a race may not participate independently of his team, offenders will be disqualified and fined from CHF 300 to 2,000.
(article introduced on 1.01.05).

National team

- 1.1.044** A national team is a team of riders selected by the national federation of their nationality.
(article introduced on 1.01.05).

Regional team

- 1.1.045** A regional team is a team of riders selected by a territorial or other division of a national federation and composed of riders licensed by that federation who do not belong to a team registered with the UCI.
(article introduced on 1.01.05).

Club team

- 1.1.046** A club team is a team affiliated to a national federation. Its composition shall be regulated by the national federation, except insofar as the riders may not belong to a team registered with the UCI.
(text modified on 1.01.05).

§ 4 Commissaires

(numbering of articles modified on 1.01.05).

[articles 1.1.112 and 1.1.122 abrogated on 1.01.04, the previous article 1.1.125 on 1.01.05]

- 1.1.047** The commissaire is an official appointed by the UCI or a national federation to ensure that cycling events comply with the provisions of the regulations that may apply.
- 1.1.048** Commissaires, both individually and/or in a panel shall direct the sporting aspects of cycling events and ensure that the event be in all respects conducted according to the regulations. They shall, in particular, ensure that the regulations specific to a race, the manner in which it is conducted and all technical provisions relating thereto comply strictly with the applicable provisions of the regulations.

Commissaires shall record breaches of the regulations and pronounce the foreseen penalties.

- 1.1.049** The commissaires' panel shall comprise commissaires appointed to supervise a given cycling event.

It shall record decisions of individual commissaires and shall apply and/or confirm the penalties imposed.

1.1.050 Each commissaire shall act neutrally and independently. He may in no way be involved in the organisation of the race. He shall immediately decline his appointment if he is aware of any aspect that could cast doubt on his neutrality.

1.1.051 The title of national commissaire shall be conferred by the national federation competent to issue his licence.

National federations shall determine the eligibility, status and functions of commissaires in accordance with the principles mentioned above.

(text modified on 1.01.17).

1.1.052 Except where an exemption is granted by the UCI, a commissaire other than an UCI international commissaire may officiate only in the country of his national federation.

(text modified on 1.01.05).

Elite national commissaires

1.1.052 bis The title of elite national commissaire shall be conferred by the UCI in the disciplines determined by the UCI, to persons having successfully completed a course approved by the UCI and given by an instructor appointed by the UCI.

Such qualification shall be a requirement for candidates for qualification as UCI international commissaire in the disciplines of Road, MTB and BMX.

(article introduced on 1.01.17).

UCI international commissaires

Conditions of appointment

1.1.053 The title of UCI international commissaire shall be conferred by the UCI to persons having passed the examination and the practical assessment referred to in article 1.1.060.

(text modified on 1.01.07).

1.1.054 To be able to be admitted to the selection procedure to become UCI international commissaire, the concerned person has to meet the following conditions:

1. be a national, respectively an elite national commissaire licence holder of a UCI affiliated national federation;
2. be proposed by that national federation. This federation is required to submit an application signed by its president or a person delegated by its president which shall include the following documentation:
 - a copy of an official identity document (passport, etc.) showing that the person - is aged between 25 and 50 years in the year of his selection by the UCI;
 - for the disciplines of Road, MTB and BMX: qualification of elite national commissaire obtained after having successfully completed an elite national commissaire course approved by the UCI given by an instructor appointed by the UCI;
 - evidence that he has served actively as a national respectively elite national commissaire in the two years preceding the selection;
3. have an excellent knowledge of the UCI regulations;

4. have a command of the official course language, which will be one of the two official UCI languages (French or English).

The final selection of candidates is operated by the UCI based on the needs, the files received, the places available. Additional criteria might be established specifically for the course.

If a false statement is made, the candidate shall be excluded from every course or examination. If applicable, he shall be stripped of the title of international commissaire.

(text modified on 1.01.03; 1.04.05; 1.01.07; 30.01.09; 1.01.10; 1.02.11; 1.02.13; 1.01.17).

1.1.055 [article abrogated on 1.01.17]

Training courses

1.1.056 The training courses shall cover both the theoretical knowledge of the regulations and their practical application in the field.

(text modified on 1.01.17).

1.1.057 Class and examination sessions shall be organised separately for each different type of programme.

The syllabus for each training course shall comprise a general part common to all disciplines and a special part specific to each discipline/category:

General part:

- UCI constitution (general)
- general organisation of cycling as a sport
- world championships
- continental championships
- Olympic and Paralympic Games (for Olympic disciplines)
- discipline and procedures
- sports safety and conditions
- antidoping controls (general)
- the psychological aspects and ethics of the position of international commissaire

Disciplines / categories

- Road
- Track
- mountain bike
- cyclo-cross
- BMX
- BMX Freestyle
- Trials
- cycle-ball
- artistic cycling
- para-cycling

(text modified on 1.01.05; 1.01.07; 25.6.07; 1.01.17).

1.1.058 The UCI shall set the examination requirements and standards for each course. Examination shall comprise a theoretical part (written and oral) and a practical part.

In the event of failure, the candidate shall be permitted to retake the examination a second time, subject to the requirements of article 1.1.054. Two failures in the same discipline shall result in exclusion for the examinations in the other disciplines.

(text modified on 1.01.03; 1.01.17).

- 1.1.059** Within 24 months of passing the theoretical examination for international commissaires, the candidate has to pass a practical exam in an international event.
A UCI shall evaluate the candidate. In the event of failure, the candidate shall be permitted to resit the practical exam only once.

(text modified on 1.01.07; 30.01.09; 1.01.17).

- 1.1.060** [article abrogated on 1.01.17]

- 1.1.061** International commissaires shall be periodically assessed to guarantee that they meet the required skill levels and in order to keep their qualification.
Commissaires are invited to attend seminars for training and improving skills on a regular basis.
These seminars conclude by an assessment of proficiency.

Commissaires are assessed in writing, orally or in practice at an event.

The seminars for training and improving skills, as well as assessments, are led by UCI tutors and assessors appointed by the UCI.

Commissaires who do not take part in the seminars for training and improving skills or are not deemed to hold the required skill levels, are not reappointed by the UCI.

If necessary, the qualification of UCI international commissaire is withdrawn.

(text modified on 1.01.04; 1.01.07; 1.01.17).

- 1.1.061 bis** [article abrogated on 1.01.17]

Status

- 1.1.062** At the maximum, a commissaire can exercise in two disciplines. Except for Road and Track commissaires who can at the same time exercise in Paracycling.
A UCI international commissaire cannot at the same time:

- be the holder of a licence as a rider of a team registered with the UCI or be member of a national team;
- exercise any technical function (team assistant, mechanic, paramedical assistant, team manager, etc.) for a national federation or a team registered with the UCI.
- Exercise the function of president or vice president within a national federation or continental confederation.

A UCI international commissaire may in no case carry out another role on the occasion of an international event.

(text modified on 1.01.00; 1.01.05; 1.01.07; 1.07.07; 25.06.07; 1.02.13; 1.01.17).

1.1.063 Members of the UCI management committee as well as UCI staff members may not officiate as international commissaires.

(text modified on 6.10.97).

1.1.064 The active career of an international commissaire shall end on 31 December of the year in which he reaches the age of 70.

However, for indoor cycling, the career of an international commissaire ends on 31st December of the year in which he reaches the age of 65.

(text modified on 1.01.07; 1.02.11; 1.10.11).

1.1.065 All international commissaires shall be subject to UCI discipline when appointed on an international event.

(text modified on 1.01.17).

1.1.066 Should an international commissaire, even when not officiating as such, commit a breach of the UCI regulations or of the Code of conduct for Commissaires or should he cause any material or moral prejudice whatsoever to cycling as a sport or to the UCI, he may shall be sanctioned as follows:

- he shall not be appointed for a period to be determined;
- his qualification shall be withdrawn.

(text modified on 1.02.07; 26.01.07; 1.01.17).

1.1.067 The matter shall be brought before the UCI Disciplinary Commission. The decision of the UCI Disciplinary Commission is final and not subject to appeal.

(text modified on 6.10.97; 1.01.03; 1.01.10; 1.01.17).

1.1.068 [article abrogated on 1.01.17]

Mission

1.1.069 The title of UCI international commissaire shall not in itself confer the right to be entrusted with a mission.

1.1.070 The commissaires shall be designated by the UCI and/or by the national federation for supervision of races on the international calendar, as indicated in article 1.2.116.

(text modified on 15.10.04; 1.02.11; 1.01.17).

1.1.071 An international commissaire, if not appointed by the UCI, may be appointed by his national federation to officiate in its country.

1.1.072 A UCI international commissaire may not accept a mission abroad without the agreement of his national federation and of the UCI, other than when appointed by the UCI. Without the agreement of the UCI, the measures listed in article 1.1.066 can be applied.

(text modified on 1.02.11).

1.1.073 International commissaires appointed for a mission by the UCI shall be entitled to reimbursement of their expenses, the amounts and payment conditions of which shall be determined by the management committee.

1.1.074 International commissaires appointed by the UCI or who sit on a commissaires' panel, the president of which is appointed by the UCI, shall wear the official uniforms provided by the UCI. Such uniforms may be worn solely during such missions.

§ 5 Sports directors

1.1.075 Each team, except regional teams and club teams, must nominate a single person as sports director.

If, within a team more than one person carries the title of sports director, the team shall designate one person as the head sports director. Other individuals are described as assistant sports director. Without prejudice to the terms of Article 1.1.077, the provisions of this section apply to the head sports director.

(text modified on 15.10.04; 1.01.13).

1.1.076 No team shall be registered with the UCI or recognised by it as a national team if no team manager has been appointed.

No team may take part in events on the international calendar if it has not appointed a team manager.

(text modified on 15.10.04).

1.1.077 The sports director shall hold the appropriate licence.

The sports director and assistant sports directors of UCI WorldTeams and UCI Professional Continental Teams must also have successfully passed the UCI examination. Failing this, they cannot be registered as such with the UCI, without prejudice to the following paragraphs.

Persons assuming the function of (assistant) sports director for the first time as of 2013 must pass the examination in effect in the year of their taking on the role. In the event of failure, the person can only be registered for the year following that in which the examination was passed.

Special provision for 2017, 2018 and 2019

(Assistant) sports directors working in 2017 must pass the examination in 2017 to be able to be registered in 2018 with a UCI Professional Continental Team. If failing the examination, the (assistant) sports director can remain registered in 2018 but must pass the examination in 2018 to be able to be registered for 2019. In the event of a further failure, this person can only be registered for the year following that in which the examination was passed.

(text modified on 15.10.04; 1.01.13; 1.01.15; 1.01.17).

1.1.078 Besides the tasks and responsibilities which are provided for in the regulations, the team manager shall be responsible for the organisation of the sporting activities and for the social and human conditions in which the riders practise the sport of cycling within the team.

(text modified on 1.01.05).

- 1.1.079** The team manager shall constantly and systematically strive, wherever possible, to improve social and human conditions and protect the health and safety of the team's riders.

(text modified on 1.01.05).

- 1.1.080** The team manager shall ensure that the regulations are complied with by all those who belong to the team or who work for it in whatever capacity.

He shall set an example to the others.

(text modified on 1.01.05).

- 1.1.081** The team manager shall ensure that there is specialist assistance for the team in the following areas: medicine, treatment in accordance with article 13.3.001 and equipment. He shall ensure that assistance is given by qualified persons and, where required, holders of a licence in accordance with the regulations.

(text modified on 1.01.04; 1.01.05).

- 1.1.082** The team manager shall ensure that tasks are appropriately divided between all the persons mentioned in article 1.1.080, with the exception of the riders. The tasks for each person shall be clearly specified and respect the regulations. Those persons with titles shall be listed by name. The division of tasks shall be in written form. A copy shall be given to all persons mentioned in 1.1.080. A copy shall also be submitted to the national federation. Teams registered with the UCI and national teams shall also submit a copy to the UCI.

(text modified on 1.01.05).

- 1.1.083** The team manager shall regularly consult all persons mentioned in article 1.1.080 regarding human and social conditions, equipment, risks involved in cycling and the competition schedule for each rider. He shall make a report on each consultation. Upon their request, a copy of the reports shall be submitted to the national federation or the UCI.

(text modified on 1.01.05).

- 1.1.084** Any failure by a team manager to meet the obligations imposed under this paragraph shall be penalised by a suspension of between 8 days and ten years, and/or a fine of between CHF 500 and 10,000. In the event of a subsequent offence occurring within two years of the first, the team manager shall be suspended for a period of at least six months or excluded permanently and fined between CHF 1,000 and 20,000.

(text modified on 1.01.05).

- 1.1.085** Any person or team failing to respect the division of tasks under article 1.1.082 will be penalised by a suspension of between one month and one year and/or a fine of between CHF 750 and 10,000. If a second infraction is committed within two years, it will be penalised with a suspension of between six months minimum or with permanent exclusion and a fine of between CHF 1,500 and 20,000.

(text modified on 1.01.05).

- 1.1.086** The team manager may be held responsible for infractions committed by persons indicated in article 1.1.080 and shall be penalised under the provisions for the infraction in question, unless he can demonstrate that the infraction cannot reasonably be considered to have been caused by negligence on his part, and that he did not endorse it in any way.

(text modified on 1.01.05).

§ 6 Technical delegate

- 1.1.087** The UCI may appoint a technical delegate to any cycling event. The role of the technical delegate is defined in the respective Parts of the regulations for each discipline.

(article introduced on 1.01.15).

Chapter II RACES

Section 1: administrative provisions

§ 1 Calendar

1.2.001 The calendar is the chronological list of cycling races by discipline, category and/or gender.
The procedure for the awarding of licences to organisers has yet to be determined.

1.2.002 A calendar shall be drawn up for the following disciplines:

1. road
2. track
3. mountain bike
4. cyclo-cross
5. BMX and BMX Freestyle
6. trials
7. indoor cycling (cycle ball and artistic cycling)
8. cycling for all
9. para-cycling

(text modified on 15.10.04; 1.01.17).

1.2.003 The calendar shall be prepared annually for a calendar year or a season.

1.2.004 In each discipline a world calendar, a continental calendar by continent and a national calendar by national federation shall be prepared.

The international calendar comprises the world calendar and continental calendars.

An international race is a race entered on a world calendar or on a continental calendar.

A national race is a race entered on a national calendar.

(text modified on 1.01.01).

1.2.005 With the exception of UCI WorldTour events, the world and continental calendars are as determined by the UCI management committee on the advice of the continental confederations for the competitions which concern them.

The calendar of UCI WorldTour events is drawn up by the Professional Cycling Council, in line with the provisions concerning the UCI WorldTour in Part II, section XV.

(text modified on 2.03.00; 15.10.04).

1.2.006 Each year, organisers shall apply to their respective national federations to have their races included on the world or continental calendar.

By filing its application, the organiser commits to respecting the UCI constitution and regulations.

The organiser of, cyclo-cross, mountain bike or BMX event registered on a national calendar in which riders of three or more foreign federations participated, two foreign federations for a track, trials or an indoor cycling event, must request the inclusion of the next edition of his event on the international calendar. The event shall not be included in the national calendar, except if its inclusion in the international calendar is rejected.

The organiser of paracycling event registered on a national calendar in which riders of many foreign federations participated, as per Article 16.18.003, must request the inclusion of the next edition of his event on the international calendar. Organisers of C1 events have to guarantee the minimum number of nations as per Article 16.18.003, otherwise downgraded as C2 events the year after, regardless of their participation.

Regarding road, National federations shall pass on applications for inclusion to the UCI with a copy to their continental confederation no later than **July** 1st of the year preceding that for which inclusion is required. For indoor cycling, para-cycling road and cycling for all, the deadline shall be set at July 1st. For MTB, BMX, BMX Freestyle and trials, this date is the last Friday of July as for track, para-cycling track and cyclo-cross, the deadline shall be set at December 15th.

The application of the national federations must be filed according to the instructions given by the UCI administration and confirms in any case the organiser's commitment to submit to the UCI constitution and regulations.

If a race is run over the territory of several countries, the race shall be included on the calendar only with the agreement of the federation of each country concerned.

If a federation does not transmit a request for inclusion on a calendar, the organiser of the race may approach the UCI directly.

(text modified on 1.06.98; 1.01.03; 1.01.04; 1.01.05; 1.07.09; 1.07.12; 25.02.13; 1.07.13; 1.01.16; 1.01.17 ; 8.02.18).

1.2.007 The draft continental calendars shall be sent by the UCI to the respective continental confederations which may state their opinions thereon within 30 days of the despatch of the draft.

Continental confederations shall, whenever publishing their continental calendars, include world calendar races that are run on their territories.

1.2.008 National calendars shall be prepared by the respective national federations.

Federations shall, when publishing their national calendars, include international calendar races that are run in their countries.

(text modified on 1.01.05).

1.2.009 The first time a race is submitted for inclusion on the international calendar, the organiser shall submit documentation including at least the following information:

- type of race (discipline, speciality, format);
- description of the course including total length (in km) and, where applicable, that of stages and circuits;
- the type and number of participating teams and/or riders' categories wanted;
- financial aspects (prizes, travel and subsistence expenses);

- references concerning organisation.

For the Road, the documentation must be submitted to the UCI no later than three months before the meeting of the management committee at which the calendar in question is finalised (in general, June 25th). For the other disciplines, the documentation must be submitted to the UCI at the latest on the same registration deadline settled in Article 1.2.006 for the other disciplines.

(text modified on 1.01.98; 1.01.04; 1.01.05; 1.07.13).

1.2.010 *(text modified on 1.01.04).*
[article abrogated on 1.01.05].

1.2.011 If the documentation is accepted, the race shall be registered for a probationary year, on a date compatible with the existing calendars. The race may be supervised by a UCI delegate at the expense of the organiser.

(text modified on 1.01.99).

1.2.012 The inclusion of a race on the international calendar shall be subject to the payment of a fee, called the calendar fee, the amount of which shall be set annually by the UCI management committee.

The total amount of the fee must be paid by the organiser to the UCI no later than two months after the meeting of the management committee at which the calendar for the discipline in question is approved. The above deadline is the date on which the UCI account must be credited.

In case of delay, a penalty of CHF 100 for each started month will automatically be applied.

The inclusion of the race on the following calendar shall be refused should the fee, as well as the penalty not have been paid one month before the meeting of the management committee at which the calendar in question is approved.

Furthermore, a race inscription shall be refused if the enrolment fees for previous races have not been paid or if the organiser does not honour its financial obligations with the UCI. This measure also applies to the new organiser of the race and, in general, to the organiser and/or race that the management committee considers to be the successor of another organiser or another race.

(text modified on 1.06.98; 1.02.03; 1.01.04; 1.01.05).

1.2.013 A rejection of an application for inclusion on the international calendar is decided by the UCI management committee. The organiser shall be allowed to put his case. If the organiser has not had an opportunity to defend his application, he may lodge an appeal with the UCI arbitral board. The decision of the arbitral board is final and not subject to appeal.

(text modified on 2.03.00; 1.01.05; 1.01.10).

1.2.014 Any change to the date of an event included on the international calendar shall be subject to prior authorisation by the UCI or, for a UCI WorldTour event, the Professional Cycling Council at the request of the national federation of the organiser. If there is a change of

date or if an event is cancelled, the organiser shall be liable for a fine the amount of which shall be set each year by the management committee, subject to recourse to the arbitral board. The decision of the arbitral board is final and not subject to appeal.

(text modified on 2.03.00; 1.01.05; 1.01.10).

§ 2 Names of races

- 1.2.015** The organiser cannot call his event by any name other than that under which it was entered on the calendar.
- 1.2.016** The national federation and the UCI may ask that the name of the race be altered, for instance to avoid confusion with another race.
- 1.2.017** No race may be designated as a national, regional, continental, world, cup or championship event, save in the cases expressly provided for in the UCI regulations or unless prior and express authorisation has been obtained from the UCI or the competent national federation with respect to races on its national calendar.
- 1.2.018** The organiser shall avoid giving the impression that his race has a status that it does not have.

§ 3 Forbidden races

- 1.2.019** No licence holder may participate in an event that has not been included on a national, continental or world calendar or that has not been recognised by a national federation, a continental confederation or the UCI.

Depending on the circumstances, a national federation and the UCI may grant special exceptions for particular races or events run in its own country.

Particular races or events may consist of:

- events organised occasionally only and which do not belong to the organised sports movement;
- events whose format is not covered by the UCI regulations.

Any national federation intending to grant a special exception must submit its reasoned request to the UCI administration in the beginning of the season and at least two months before the respective event. The decision of the UCI in this respect is final and shall not be subject to appeal.

(text modified on 25.09.14)

- 1.2.020** Licence holders may not participate in activities organised by a national federation that has been suspended, save in application of article 18.2 of the UCI constitution.
- 1.2.021** Breaches of articles 1.2.019 or 1.2.020 shall render the licence holder liable to one month's suspension and a fine of CHF 50 to 100.

§ 4 Access to a race

1.2.022 No suspended licence holder may be admitted to a race or to zones not accessible to the public.
Anyone knowingly engaging or entering a suspended rider for a race shall be fined between CHF 2,000 and 10,000.

1.2.023 The organiser shall grant accreditation and free access to members of the bodies of its national federation and of the UCI.

§ 5 Sanction

1.2.024 The result of each race shall be sanctioned by the national federation of the organiser as fast as possible after the end of the competition.

(text modified on 1.01.98; 1.01.05).

1.2.025 National federations shall make absolutely sure that the results of the race are not being contested before sanctioning them.

§ 6 Classifications and cups

1.2.026 National federations, their affiliates and licence holders and, in general, all bodies answerable to them shall be barred from participating actively or passively in any individual or team classification based on the races on the international calendar other than those drawn up or expressly authorised by the UCI.

Events conducted by an organiser who fails to comply with the preceding paragraph shall be deleted from the international calendar for the following year.

In no case, for mountain bike and cyclo-cross, such a classification will not be comprised of more than eight events.

(text modified on 1.08.00; 1.01.05; 1.07.13).

§ 7 National Championships

1.2.027 National championships shall be ridden under UCI regulations.

1.2.028 Participation in national championships shall be regulated by the respective national federations. Only riders who have held the nationality of the country for the purposes of the present regulations as from January 1st of the year may compete for the title of national champion and the relevant points.

If a national federation organises a separate event to award the national champion's title in a given category, riders in this category may not take part in the national championship event in another category. A maximum of three national federations may organise their national championships as a joint event.

(text modified on 1.01.05).

Dates of the National Championships

1.2.029 National road championships shall be organised during the last full week of the month of June. All results must be received by UCI by email no later than two days after the last day of the event. No result received after that time shall be taken into consideration for the UCI classification. UCI points awarded will be included in the ranking calculated on the week following the receiving of the results.

The national cyclo-cross championships shall be run on the date set by the Management Committee.

National mountain bike championships of cross-country Olympic (XCO) shall be run on the 29th weekend of the year.

National BMX championships shall be run on the first weekend of July.

National trials championships shall be run on the last weekend of June. However, it is possible to run them together with the national mountain bike championships, on the 29th weekend of the year.

National indoor cycling championships should take place 4 weeks before the world championships.

The UCI may grant dispensations for the southern hemisphere or in cases of force majeure.

Concerning the calculation of the UCI rankings, national championships run before or after the mandatory date shall be considered as being run on the mandatory date, except for road cycling.

(text modified on 1.01.04; 1.01.05; 1.09.05; 1.01.06; 1.01.08; 1.07.10; 1.07.12; 1.07.13; 1.01.16; 3.06.16).

§ 8 Betting

1.2.030 Anyone subject to the UCI regulations may not be involved directly or indirectly in the organisation of bets on cycling competitions, under penalty of a suspension of between 8 days and one year and/or a fine of CHF 2,000 to 200,000.

In addition, if an organiser is involved, any competition organized by him may be excluded from the calendar for one year.

Comment: this provision should not be interpreted as excluding commercial sponsorship agreements between teams and companies that provide betting services, provided the team has provided to the UCI or national federation proof that (i) sufficient safeguards exist to separate the company's betting activities from the team sporting operations and (ii) that the betting company shall withhold from organising bets that may be seen as putting the principles of sporting integrity and fairness at risk.

(text modified on 1.01.00; 1.01.05; 14.08.17).

§ 9 Sponsoring

1.2.030 Without prejudice of the applicable law, no brand of tobacco, spirits, pornographic

bis products or any other products that might damage the image of the UCI or the sport of cycling in general shall be associated directly or indirectly with a licence-holder, a UCI team or a national or international cycling competition.

As defined in the present article, a spirit is a beverage with a content in alcohol of 15% or more.

Besides the refusal of the licence, the registration of the team and the registration of the race, breaches of this article are punished as follows:

- Refused start and fine from CHF 1,000 to 200,000 for a team
- Refused start and fine from CHF 1,000 to 25,000 for a licence-holder
- Removal of the race from the calendar and/or fine from CHF 5,000 to 500,000 due jointly by the licence-holder, the owner and the organiser of the race.

(article introduced on 1.07.10).

Section 2: organisation of races

(numbering of articles modified on 1.01.05).

§ 1 Organiser

1.2.031 The organiser of a cycling race shall be licensed as such. He shall be a licence holder of the national federation of the country where the race is run.

1.2.032 The organiser shall be entirely and exclusively responsible for the organisation of his race, with respect both to compliance with UCI regulations and to the administrative, financial and legal aspects.

The organiser alone shall be responsible to the authorities, participants, attendants, officials and spectators.

The organiser shall be responsible for financial obligations arising from previous occasions on which that event was organised by a third party or from those to which his event is considered to be the successor by the management committee or, where the event in question is a UCI World Tour event, by the Professional Cycling Council.

(text modified on 2.03.00; 1.01.05).

1.2.033 Monitoring by the UCI, national federations and by the commissaires of the conduct of the race shall concern only the sporting requirements and the organiser alone shall be answerable for the quality and safety of the organisation and installations.

1.2.034 The organiser shall take out insurance covering all risks relating to the holding of his race. This insurance must nominate the UCI as a jointly insured party and cover claims which may be made against the UCI in connection with the event.

(article modified on 1.01.05).

1.2.035 The organiser shall take whatever safety measures caution demands.

The organiser shall ensure that the race may take place under the best material conditions for all parties concerned, riders, attendants, officials, commissaires, journalists, security services, medical services, sponsors, the public, etc.

Unless otherwise specified, the organiser must provide all the equipment required for the organisation of the event, including all timing equipment.

(text modified on 1.01.06).

1.2.036 The organiser shall always strive to attain the best quality of organisation possible with the means at his disposal.

§ 2 Authorisation to organise the event

1.2.037 A cycle race may be organised only if it has been included on a national, continental or world calendar.

The inclusion of the race on the calendar means that its organisation has been authorised, but does not imply that the UCI or the national federation that registered it undertake responsibility for it.

1.2.038 In addition, the organiser shall obtain any administrative authorisations required under the laws and regulations of the country where the competition is held.

(text modified on 1.01.05).

1.2.039 The organiser shall, within the deadline set by his national federation, submit to it the technical file on that race comprising at least the following data (if applicable):

- the specific regulations for the race; these regulations may not be published in the programme until they have been approved by the national federation;
- programme and schedule of competitions;
- invited riders (categories of rider, teams, etc.);
- entry procedure, distribution of identification numbers;
- list of prizes;
- financial conditions relating to travel and subsistence expenses;
- arrangements for in competition feeding (method, number, feed zones, etc.);
- transport arrangements for participants and baggage;
- description and detailed plans of the track or circuit, including start and finishing zones;
- location of podiums and rooms for antidoping tests, secretarial offices, pressroom, etc.;
- arrangements regarding police and security forces and set-up in case of medical emergency;
- photo-finish and time-keeping installations;
- public announcement facilities and announcers;
- for para-cycling events, information on accessibility services shall be provided.

(text modified on 1.01.05; 1.07.11).

§ 3 Specific regulations

1.2.040 The organiser shall draw up a set of regulations specific to his race.

The regulations shall inter alia cover sporting aspects particular to the race.

These specific regulations shall comply fully with the present regulations and have been approved beforehand by the national federation of the organiser.

1.2.041 (N) The specific regulations shall be published in the programme and/or the technical guide for the race.

§ 4 Programme - technical guide

1.2.042 (N) The organiser shall prepare a programme and/or technical guide for his race, which must be approved in advance by his national federation.

The contents shall be determined by the provisions governing the various disciplines.

It shall, at least, be written in French or English; other languages may be added.

- 1.2.043** With the exception of minor alterations to the timetable for the competition, provisions once published in the programme and/or technical guide can no longer be altered save with the agreement of all concerned or where it is necessary to bring them into line with the regulations.

The organiser may, if necessary, make a substantial change to the timetable for the event subject to the following conditions:

- 1) he must notify the teams or riders and the international commissaires at least 15 days in advance;
- 2) he must repay the teams or riders, commissaires, national federations and the UCI any irrecoverable costs caused by the change to the timetable.

(text modified on 1.01.04).

- 1.2.044** Any breach of the provisions relating to the programme or technical guide shall render the organiser liable to a fine of between CHF 500 and 2,000.

- 1.2.045** The organiser shall send the programme and/or technical guide to all teams or riders invited to participate in the race, at the latest when they confirm their enrolment.

The organiser shall send the programme and/or technical guide to the international commissaire(s) 30 days before the date of the race.

- 1.2.046** At the team managers' meeting, the organiser shall provide a sufficient number of copies of the programme and/or technical guide of the race for distribution to the riders.

- 1.2.047** By participating in a race, a rider shall be assumed to know and to have accepted the content of the programme and/or technical guide, including the specific race regulations.

§ 5 Invitation – Enrolment

General principle

- 1.2.048** (N) Unless otherwise specified, the organiser is free to select any teams and riders for an event, without any requirement to take account of any national protection.

Without prejudice to the provision concerning Mountain bike, BMX, indoor cycling, para-cycling, cycling for all and the Masters category, organisers of events registered on the international calendar are not allowed to demand from riders and/or teams any participation fee whatsoever (contribution to costs, entry fee, etc.).

(text modified on 1.01.02; 1.01.04; 1.01.05; 23.09.05; 1.02.07; 1.07.11; 1.07.13).

Conditions

- 1.2.049** The organiser shall, at least 60 days in advance, invite the team or rider by sending general information. In the case of national, regional or club teams, he shall notify the national federation of the invitation.

At least 50 days before the race, an invited party shall inform the organiser in writing (letter, fax, email) whether he/it wishes to participate in the race or whether he/it wishes to decline the invitation.

At least 40 days before the race, the organiser shall send an official UCI entry form to all invited parties whose participation he accepts. At the same time, he shall inform invited parties whose participation he does not accept to that effect.

At least 20 days before the race, the invited party shall return to the organiser the original of the duly completed entry form.

72 hours before the event's start time, the teams must fax or email the organiser a copy of the entry form giving the names of the entrants plus two reserves.

Any party failing to meet the prescribed deadlines shall forfeit its rights.

(text modified on 1.01.01; 1.01.03; 1.01.04; 1.01.05; 1.10.10).

- 1.2.050** The organiser shall submit the entry forms to the commissaires' commission for verification.

General provisions

- 1.2.051** In a national calendar race, the entry procedures shall be determined by the national federation of the organiser.

- 1.2.052** National, regional and club teams and their respective riders may not start in competitions abroad unless they hold authorisation in writing issued by their federation (except teams and riders from the same federation as the event organiser). This authorisation must carry the dates of validity and the name(s) of the rider(s) concerned.

The provisions in this article shall not apply to riders covered by the provisions of article 2.1.011.

(text modified on 1.01.01; 1.01.04; 1.01.05).

- 1.2.053** In the event that a UCI registered team is entered but fails to appear, the signatory of the entry and the team that he represents shall be jointly and severally liable to pay the organiser an indemnity equal to twice the travel and subsistence expenses agreed in writing.

In other cases of failure to start, the signatory of the entry and the team which he represents shall be jointly and severally liable to pay the organiser a penalty charge equal to the travel and subsistence expenses agreed in writing.

(text modified on 1.01.02; 1.01.04; 1.01.05; 1.02.14).

- 1.2.054** The organiser may not accept late entries. The organiser must inform the signatory of the entry in question of this. The president of the commissaires' panel shall rule in the event of dispute.

The organiser may not refuse to allow a team or a rider entered to start. He must submit his objections to the commissaires' panel which shall decide.

Should the organiser refuse without valid reason to allow an entered team to start in an event of road class HC or 1, the organiser must pay the team an indemnity equal to double the total sum of the allowances for the event.

(text modified on 1.01.02; 1.01.05).

Penalties

- 1.2.055** The following infringements shall be penalised as indicated below:
1. Rider contracted (identification number issued) absent at the start:
 - if not participating in any other event: a CHF 50 fine;
 - if participating in another event: exclusion from the classification and a fine of between CHF 500 and 3,000.
 2. Failure on the part of the organiser to use the official entry form:
 - fine of between CHF 300 and 1,000 per team.

(text modified on 1.01.05).

§ 6 Race headquarters – Secretarial office

- 1.2.056** (N) The organiser shall provide a fully equipped secretarial office for the full duration of the race. A representative of the organiser must be present there at all times.

(article introduced on 1.01.05).

- 1.2.057** (N) This race headquarters will be set up at the competition venue. For road races, the race headquarters will be operational at the start location during the two hours that precede the start of the race, as well as at the finish location, during the two hours that precede the finish of the race.

- 1.2.058** (N) The race headquarters at the finish will remain open until the results are sent to the UCI, or, if the commissaires have not completed their work at that juncture, until such time as that work has been completed.

(article introduced on 1.01.05).

- 1.2.059** (N) The race headquarters must be provided with at least a telephone line, a fax and a computer with internet access.

(article introduced on 1.01.05).

§ 7 Course and safety

Safety

- 1.2.060** The organiser must provide an adequate security service and organise efficient cooperation with the police.

(article introduced on 1.01.05).

- 1.2.061** Without prejudice to the relevant legal and administrative provisions and the general duty of care, the organiser shall ensure that the race course or the competition grounds include no places or situations that could constitute a particular safety risk to anyone (riders, attendants, officials, spectators, etc.).

(text modified on 1.01.05).

- 1.2.062** Without prejudice to provisions requiring an entirely closed circuit, all traffic shall be stopped on the course as the race passes through.

1.2.063 In no case can the UCI be held responsible for defects in the course or installations of for any accidents that may occur.

(text modified on 1.01.05).

1.2.064 Riders shall study the course in advance.

Unless ordered so to do by a police officer, they may not leave the prescribed course and shall not be able to claim any error in this respect, nor any other motive such as, for example, incorrect directions by any person, badly placed or non-existent signs, etc.

Conversely, should the rider take a shortcut giving an advantage, he shall be penalised in accordance with article 12.1.040.15, notwithstanding any other disciplinary measures that may be provided for.

(text modified on 1.01.07).

1.2.064 bis It is strictly prohibited to use sidewalks/pavements, paths or cycle paths that do not form part of the course (i.e. those separated by kerbs, verges, level changes or other physical features) if a dangerous situation is created inter alia for other riders, spectators or race personnel by such action or if such action procures a significant advantage over other riders. Non-respect of this requirement is sanctioned in accordance with Article 12.1.040.14bis, without prejudice to any other sanctions that may apply.

(article introduced on 1.10.13; text modified on 7.03.14).

1.2.065 If one or more riders leave the circuit on the orders of a police officer, they will not be punished. If that detour gives an advantage, the riders concerned shall wait when they return to the normal course and then restart in the positions they occupied before the detour.

If all or some of the riders take the wrong route, the organiser shall do all he can to direct the riders back to the course at the place where they left it.

1.2.065 bis Without prejudice to stricter requirements according to the national legislation, the use of drones is prohibited above the course and within 10 meters from the course.

Moreover, the user must ensure the drone at no time puts the security of riders, followers and spectators at risk.

(article introduced on 1.01.18)

§ 8 Medical service

1.2.066 The organiser shall set up an adequate medical service.

1.2.067 The organiser shall appoint one or more doctors to provide riders with medical care.

1.2.068 Facilities for rapid transfer to hospital must be available. At least one ambulance shall follow the competition or be available at the competition venue.

Prior to the start of the event, the organiser must make available to starting teams a list of the hospitals contacted to handle any injuries.

(text modified on 1.01.98; 1.01.05).

§ 9 Prizes

1.2.069 All information on prizes (number, nature, amount, conditions of awarding) shall be clearly stated in the programme or technical guide of the race.

1.2.070 The management committee may set minimum prize levels for events on the international calendar.
For UCI World Tour events, the total minimum prize value is determined by the Professional Cycling Council.

(text modified on 2.03.00; 1.01.05).

1.2.071 No more than 30 days before the race, the organiser shall pay over to his national federation a sum covering the total value of the prizes. The national federation shall ensure that they be distributed.
The payment may be replaced by a bank guarantee; in this case the prizes shall be paid out by the organiser.

1.2.072 Prizes shall be paid to the beneficiaries or their representatives no later than 90 days after the finish of the race.

1.2.073 If there is any dispute that might influence placing and hence entitlement to a prize, the prize shall be withheld until a decision has been reached.
Unless specially provided otherwise, the following riders in the classification shall each advance by one place and shall be entitled to the prizes corresponding to their new places.
Should a rider or a team lose the place that entitled him or them to a prize, the prize must be returned within one month to the organizer who shall proceed to its redistribution. In the event of non-compliance, the total amount repayable shall be increased automatically by 20% (twenty percent) and the organiser may refer the matter to the UCI. The rider or team shall be suspended automatically if the prize, increased by 20% (twenty percent), has not been repaid in the hands of the UCI within one month of notice being given by the UCI until such time as the total amount due has been repaid.
The last paragraph applies also to any intermediary or beneficiary in possession of the prize as from the moment that the request for repayment is made.

(text modified on 1.01.05; 1.10.05; 1.01.09).

1.2.074 If a race or a stage is ridden at an abnormally low average speed, the commissaires' panel may, after consulting the organiser, decide to reduce or cancel prizes.

§ 10 Travel and subsistence expenses

1.2.075 1. Without prejudice to the provisions below, the contribution made by the organiser to the travel and subsistence expenses of the teams or riders in an event on the international calendar shall be negotiated directly between the parties.

The subsistence allowance shall include accommodation, meals and drinks (only mineral water) during the event.

2. For certain events, the management committee or the Professional Cycling Council may oblige the organisers to pay a participation allowance and fix the minimum amount of the allowance.

The participation allowances shall be deemed to cover travel expenses.

(text modified on 1.01.02; 1.01.03; 1.01.05; 1.01.06; 1.10.09).

- 1.2.076** The allowance due will be paid no later than the end of the event.
For races of 4 days or more, the agreed allowance shall be invoiced by the team and will be paid via bank transfer by the organizer to the team on an agreed upon date.

Special provisions for Road events

For Men Elite UCI WorldTour, HC class and class 1 events as well as Women Elite UCI WorldTour and class 1 events, the allowance must be paid within 30 days from the day a corresponding invoice has been issued by the team; this may only be validly issued from the day after the end of the event.

In the case of an unjustified delay in payment of the participation allowance, the team is fully entitled to interest on arrears of 15% per year without the requirement for prior notice. Furthermore, unless there has been referral to the UCI Arbitral Board in the meantime, the amounts below shall be payable as a penalty provided that the team issues formal notice to the organiser at least 10 days before the implementation of each penalty:

- 50% of the agreed allowance in the case of a delay of more than 30 days;
- 50% of the agreed allowance in the case of a delay of more than 60 days.

(text modified on 1.01.05; 1.10.13; 1.01.15; 1.01.16; 1.01.17).

Section 3: race procedures

(numbering of articles modified on 1.01.05).

§ 1 Supervision of the organisation and competition

1.2.077 The material administration of the race shall be assumed by the organiser or his representative.
Purely material organisational problems shall be solved by race administration in accordance with applicable regulations and after consulting the commissaires' panel.

1.2.078 The president of the commissaires' panel, together with the other commissaires, shall take on the sporting administration and supervision of the competition.

(text modified on 1.01.05).

§ 2 Conduct of participants in cycling races

1.2.079 All licence holders shall at all times be properly dressed and behave correctly in all circumstances, even when not racing.

They shall refrain from any acts of violence, threats or insults or any other improper behaviour or from putting other persons in danger.

They may not in word, gesture, writing or otherwise harm the reputation or question the honour of other licence holders, officials, sponsors, federations, the UCI or cycling in general. The right of criticism shall be exercised in a motivated and reasonable manner and with moderation.

1.2.080 All licence holders shall, in whatever capacity, participate in cycling races in a sporting and fair manner. They shall look to contributing fairly to the sporting success of the race.

1.2.081 Riders shall sportingly defend their own chances.
Any collusion or behaviour likely to falsify or go against the interests of the competition shall be forbidden.

1.2.082 Riders shall act with utmost caution. They shall be held responsible for any accidents that they cause.

They shall, in the way they behave in the race, observe the legislation of the country where the race takes place.

1.2.083 Carrying and using glass containers shall be forbidden during competitions.

§ 3 Team manager

1.2.084 During events, each team, except regional and club teams, shall be managed by a team manager appointed for this purpose.

(text modified on 1.01.99; 1.01.05).

- 1.2.085** The team manager shall ensure that the riders of his team attend at the required times and places (signing on, start line, antidoping control, etc.). He shall respond when summoned by the president of the commissaires' panel or by the organisation's management.

(text modified on 1.01.99).

- 1.2.086** The team manager may represent the riders before the commissaires' panel.

§ 4 Team managers' meeting

- 1.2.087** No more than 24 hours and no less than two hours before the start of the competition, the organiser must convene a meeting in a suitable room with the representatives of the organisation, the team managers, the commissaires and, where appropriate, the persons responsible for neutral vehicles and the services of public order, to coordinate their respective tasks and to take note of the specific characteristics of the event and safety measures as concern their own fields.

For world cup cyclo-cross events, the meeting must take place the day prior to the start of competition.

For mountain bike events at the world championships, World Cups, continental championships, hors classe stage races and class 1 stage races, the meeting must take place the day before the start of competitions.

(text modified on 1.1.04; 1.01.05; 1.01.06; 1.01.08; 1.01.09; 1.10.13; 1.01.15; 1.01.16; 1.01.18).

- 1.2.088** At the meeting, the commissaires shall reiterate the applicable provisions of the regulations, especially those relating to the specific characteristics of the race. The organiser shall announce any specific legal provisions that may be applicable, e.g. in connection with doping.

The meeting shall take the form determined for that purpose by the UCI.

(text modified on 1.1.04; 1.01.05).

§ 5 Entry check

- 1.2.089** The organiser shall provide the commissaires' panel in due time with a list of riders who have entered for the race and who have been confirmed as titular riders or reserve riders (entry list).

(text modified on 1.01.02).

- 1.2.090** Before the team managers' meeting as per article 1.2.087, the team manager - or his representative - must confirm the identity of the riders who will be starting to the commissaires' panel **by signing the entry form (art. 1.2.050) and clearly highlighting the names of starting riders.** The commissaires' panel shall check the licences of these riders and ensure that they are included on the list of entrants.

Riders confirmed as starters can no longer be substituted, without prejudice to provisions of the UCI Regulations providing otherwise.
The commissaires' panel shall also check authorisations to participate from the national federation required under article 1.2.052.

The operations above must be organised such that they are completed at the latest by 15 minutes before the team managers' meeting.

(text modified on 1.01.02; 1.01.04; 1.01.05, 1.05.16, 1.05.17; 1.01.18).

1.2.091 A rider whose licence has been checked shall receive his identification number(s).

(text modified on 1.01.04; 1.01.05).

1.2.092 A rider whose licence could not be verified and whose status as a non-suspended licence holder cannot be established in any other manner may not start and may not figure in the classification of the event.

(text modified on 1.01.05).

1.2.093 The licence check shall take place in an area of sufficient size and which is inaccessible to the public.

§ 6 Start of the race

1.2.094 For road races, the riders must sign the signature sheet under the supervision of a commissaire prior to the start.

(text modified on 1.01.04; 1.01.05; 3.06.16).

1.2.095 The start shall be given by means of a pistol, a whistle, a bell, a flag or by electronic means.

1.2.096 The start shall be given by – or under the control of – a commissaire (the starter) and he alone shall judge the validity of the start.

1.2.097 A false start shall be indicated by a double pistol shot, a double-whistle or a double bell-chime.

1.2.098 The commissaires shall verify that riders present on the start line are equipped according to the regulations (bicycle, clothing, identification numbers, etc.)

(text modified on 1.01.05).

§ 7 Finish

Finish line

1.2.099 The finish line shall comprise a line of 4 cm in width, painted in black on a white strip 72 cm wide thus leaving 34 cm of white on each side of the black line. For mountain bike races the white strip must be 20 cm, thus leaving 8 cm on each side of the black line.

(text modified on 1.01.04; 1.01.05).

1.2.100 The finish occurs at the instant that the tyre of the front wheel meets the vertical plane rising from the starting edge of the finishing line. To this end, the verdict of the photo-finish shall be final.

Unless otherwise specified, the finish may also be observed using any appropriate technical means that is accepted by the commissaires' panel.

(text modified on 1.01.00; 1.01.04; 1.09.04; 1.01.05).

1.2.101 In road, mountain bike, BMX and cyclo-cross events, a banner labelled "FINISH" must be fixed above the finishing line and perpendicular to the road or course. Should the banner have disappeared or been damaged, the finish line shall be indicated by a black and white chequered flag.

A banner shall also be used for any finish or for the passing of any intermediate point for a classification as well as at the top of mountain passes during road races. Should the banner have disappeared or been damaged, a black and white chequered flag shall be used.

For road races two panels placed on each side of the road can be used instead of a banner to indicate the intermediate and mountain passes. The panels must be of sufficient height to guarantee their visibility by the riders and follow vehicles.

(text modified on 1.01.05; 1.07.11; 1.01.15).

1.2.102 (N) A photo-finish with electronic timing strip is required for the following events:

- road races
- track races
- Olympic and Paralympic Games, world championships and world cup mountain bike events
- BMX races.

For cyclo-cross world cup events, only a photo-finish is obligatory.

(text modified on 1.01.04; 1.01.05; 1.01.06).

1.2.103 The film, the electronic timing strip and any other medium on which the finish is recorded shall be deemed to be valid documents. They may be consulted by all parties concerned if the finishing order should be disputed.

(text modified on 1.01.05).

Time-keeping

1.2.104 For each race, the national federation of the organiser shall designate a sufficient number of timekeeper-commissaires duly licensed by it. Timekeeper-commissaires may be helped in matters other than time-keeping operations proper by other persons licensed by the national federation of the organiser.

(text modified on 1.01.05).

1.2.105 Timekeeper-commissaires shall record the times on a form that they shall sign and hand to the finishing judge.

(text modified on 1.01.05).

- 1.2.106** Times shall be taken using an electronic time-keeping machine.
In track races and mountain bike downhill and four cross (4x) races, times shall be taken to the nearest 1000th of a second.

In other races, the times shall be taken to the nearest second at least. Results shall be communicated to the second.

Moreover, manual time-keeping will be undertaken whenever deemed necessary or useful.

- 1.2.107** When several riders finish in a group, all riders in the same group shall be credited with the same time.
If there is a difference of one second or more between the back of the back wheel of the last rider in a group and the front of the front wheel of the first rider of the following group, the timekeeper-commissaires shall give a new time taken on the first rider of this group. Any difference of one second or more (back wheel – front wheel) between riders implies a new time.

(text modified on 1.01.05; 1.01.09).

Classification

- 1.2.108** Unless otherwise stated, each rider shall, in order to be classified, complete the race entirely through his own effort, without the assistance of any other person.

- 1.2.109** The rider may cross the finish line on foot, provided that has his bicycle with him.

(text modified on 1.01.05).

- 1.2.110** The finishing order, the number of points won and the number of laps ridden shall be recorded by the finish line-commissaire. If need be, the classification shall be established using the technical resources available.

(text modified on 1.01.05).

- 1.2.111** Without prejudice to any changes resulting from the application of the regulations by the competent bodies, the classification of the race may be corrected by the organiser's national federation within 30 days of the end of the race in the event of material errors in the recording of the riders' finishing order.

The organiser's national federation shall notify the organiser and all riders involved of any such correction, if necessary through their team. For races on the international calendar, it shall also notify the UCI. The organiser's national federation shall also ensure that any issues resulting from the correction of the classification shall be resolved correctly.

(text modified on 1.01.98; 1.01.05).

§ 8 Awards ceremony

1.2.112 All riders concerned shall, in accordance with their placing, classifications and performances, participate in official ceremonies such as the presentation of jerseys, bouquets or medals, laps of honour, press conference and the like.

1.2.113 Unless otherwise stated, riders shall appear at official ceremonies wearing competition clothing.

For road events riders shall appear at official ceremonies no later than 10 minutes after their arrival, unless under exceptional circumstances.

Whenever two races on the international calendar are organised on the same day and in the same location, the organiser may hold the official ceremony jointly for both races. The ceremony for the first race shall however be held no more than two hours after the finish.

(text modified on 15.10.04; 1.01.13; 1.01.15; 1.01.17).

Section 4: supervision of races

(numbering of articles modified on 1.01.05).

§ 1 General provision

- 1.2.114** The supervision of races on national calendars shall be regulated by the national federation of the organiser.
The supervision of races on the international calendar shall be regulated by the present section.

(text modified on 1.01.05).

§ 2 Commissaires' panel

Task and composition

- 1.2.115** The proceedings at cycling races shall be supervised by a commissaires' panel.

The organiser shall take particular care to ensure that the commissaires may work in optimum conditions.

- 1.2.116** The commissaires' panel shall comprise commissaires appointed as per article 1.1.070. The number and status of the commissaires to be appointed for each race shall be as indicated in the table below.

Where applicable, and subject to availability, national federations shall respect the following order of priority when appointing commissaires: international commissaire, elite national commissaire (for Road, MTB and BMX), national commissaire:

(text modified on 1.01.05; 26.01.07; 1.02.11; 1.10.11; 1.07.12; 1.02.13; 1.01.17).

UCI CYCLING REGULATIONS

ROAD

Position and status	Appointed by	OG	CM	CC, RG	CMM UWCT	UWT	Grands Tours	HC	1cl	2cl	WWT	MJ, MU, WJ	NC
President	UCI	1											-
	NF	-											1***
Member	UCI	7	6	-	-	2	3	-					
	NF	-	-	3*	3*	-	-	2*	2**	2***	2**	2***	2***
Timekeeper (for stage races)	NF	1*** (2 Timekeepers are recommended for time trial stages)											
Finish line Commissaire	NF	1***											
Minimum additional commissaires officiating in cars or on motorcycles depending on the number of participants and the nature of the course.	NF	6***	10	5***	9***	3**	4**	3***	3***	3***	3***	3***	3***

* UCI international commissaire

** UCI international commissaire. In absence of UCI international commissaire in the country, one commissaire can be elite national commissaire of the country.

*** UCI international commissaire, elite national commissaire or national commissaire (following such order)

UCI CYCLING REGULATIONS

CYCLO-CROSS

Position and status	Appointed by	CM	CMM	CDM	CC	CL1	CL2	NC
President	UCI	1						-
	NF	-						1**
Finish Judge	UCI	1	-					
	NF	-	1**	1*		1**		1**
Member	UCI	2	-					
	NF	-	1*	2*	1*	1*	1**	1**
Additional commissaires	NF	4**	3**		4**	3**	2**	3**

* UCI international commissaire

** UCI international commissaires or national commissaire

UCI CYCLING REGULATIONS

TRACK EVENTS

Position and status	Appointed by	Olympic and Paralympic Games	World Championships	Juniors World Championships	Masters World Championships	Continental Championships and Regional games	World Cup	C1	C2	National Championships
President of the commissaires' panel, UCI international commissaire	UCI	1	1	1	1	1	1	1	-	-
	NF	-	-	-	-	-	-	-	1*	1*
Secretary of the commissaires' panel, UCI international commissaire	UCI	1	1	1	-	-	1	-	-	-
	NF	-	-	-	1	1	-	1	-	-
Secretary of the commissaires' panel, national commissaire	NF	-	-	-	-	-	-	-	1	-
Starter, UCI international commissaire	UCI	1	1	1	-	-	1	-	-	-
	NF	-	-	-	1	1	-	1	-	-
Starter, national commissaire	NF	-	-	-	-	-	-	-	1	-

UCI CYCLING REGULATIONS

TRACK EVENTS

Position and status	Appointed by	Olympic and Paralympic Games	World Championships	Juniors World Championships	Masters World Championships	Continental Championships and Regional games	World Cup	C1	C2	National Championships
Referee, UCI international commissaire	UCI	1	1	1	-	-	1	-	-	-
	NF	-	-	-	1	1	-	1	-	-
Referee, national commissaire	NF	-	-	-	-	-	-	-	1	-
Member of the commissaires' panel (minimum number), UCI international commissaire	UCI	1	3	3	-	-	1	-	-	-
	NF	-	-	-	-	-	-	-	-	-
Member of the commissaires' panel (minimum number), national commissaire	NF	-	-	-	-	1	-	-	-	-
Additional commissaires, UCI international or national commissaires	NF	10	12	10	10	10	11	5	5	-

* in absence of UCI international commissaire in the country, the choice of a national commissaire must be submitted to the UCI beforehand.

(text modified on 15.07.08; 1.02.10; 1.07.12; 15.03.16)

UCI CYCLING REGULATIONS

MTB

Position and status	Appointed by	OG	CM	CM (Marathon)	CMM (Masters)	CDM	SHC, HC	S1, S2, C1, C2	C3	Marathon Series, Enduro	CC	RG	NC
President	UCI	1											-
	NF	-											1***
Assistant president	UCI	1		-	1****	-							
	NF	-	-	1**	1*	1**				1*	1**	1***	
Secretary	UCI	1		-	1	-							
	NF	-		1*	1***				1*	1***			
Start line commissaire - 1 for XC events - 1 for DHI events - 2 for XC and DHI events	UCI	1	2	1	-								
	NF	-		2***	2*	2***				2*	2***		
Finish line commissaire	UCI	1		-									
	NF	-		1***	1*	1***				1*	1***		
Additional commissaires. Depending on the number of participants and the nature of the course	NF	2**	4-6***			2-4***	2***	1***	-	4-6***			0-2***

* UCI international commissaire

** UCI international commissaire. In absence of UCI international commissaires in the country, elite national commissaire should be appointed

*** UCI international commissaire, elite national commissaire or national commissaire (following such order)

**** UCI international commissaire appointed only if it is a double event: XCO and DHI

TRIALS

Position and status	Appointed by	CM	CDM	HC	C1	CC	JMJ	CN	
President of the commissaires' panel, UCI international commissaire	UCI	1							-
	NF	-							1**
Secretary of the commissaires' panel	UCI	1		-			1	-	
	NF	-		1*			-		
Minimum zone commissaire, depending on the number of participants and the nature of the course	UCI	4		-					
	NF	5**							

* UCI international commissaire

** In absence of UCI international commissaire in the country, national commissaire must be appointed

UCI CYCLING REGULATIONS

BMX

Position and status	Appointed by	OG	CM	CDM	RG; CC	HC; C1	CN
President	UCI	1					-
	NF	-					1***
Assistant	UCI	1			-		
	NF	-			1*	1**	1***
Secretary	UCI	1	1	1	-		
	NF	-			1*	1**	1***
Member	UCI	2	4	1	-		
	NF	-	1**			1**	1***
Additional commissaires	NF	4***	9 ***	4 ***			-

* UCI international commissaire

** UCI international commissaire. In absence of UCI international commissaires in the country, national elite commissaire should be appointed

***UCI international commissaire, national elite commissaire or national commissaire (following such order)

UCI CYCLING REGULATIONS

INDOOR

Position and status	Appointed by	Cycle-ball	Artistic Cycling	Cycle-ball	Cycle-ball CL A events	Artistic Cycling CL A events	Cycle-ball CL B events	Artistic Cycling CL B events
		CM		CDM				
President of the commissaires' panel	UCI	1			-			
	NF	-			1*	1**		
Members of the commissaires' panel	UCI	5	6	3 (4 at final)	-			
Members of the commissaires panel	NF	-			2*(Coming from two different nations)	2*(Coming from two different nations, announcing commissaires)	2**	2**(announcing commissaires)
		-				2 licensed writing commissaires		2 licensed writing commissaires

*International commissaire

**International or national commissaire

PARACYCLING

Position and status	Appointed by	PG	CM	CDM	C1	C2
President	UCI	1				-
	NF	-				1*
Secretary	UCI	1			-	
	NF	-				
Member	UCI	4		1	-	
Minimum additional commissaires, depending on the number of participants and the nature of the course	NF	10	7		3	

* UCI international commissaire

- 1.2.117** (N) The commissaires' panel shall be assisted by timekeeper-commissaire- and a commissaire secretary, appointed and licensed by the national federation of the organiser.

(text modified on 1.01.05).

President of the commissaires' panel

- 1.2.118** The president of the commissaires' panel shall be appointed by the national federation of the organiser or by the UCI, as appropriate.

The president of the commissaires' panel or a commissaire appointed by him shall act as competition director.

(text modified on 1.01.05).

Finish line commissaire

- 1.2.119** One of the members of the commissaires' panel shall act as finish line-commissaire.

The finish line commissaire may, on his own responsibility, co-opt other persons appointed and licensed by the national federation of the organiser to assist him.

(text modified on 1.01.05).

- 1.2.120** The finish line commissaire shall be the sole judge of the finish. He shall, on a special form that he shall sign and hand in to the president of the commissaires' panel, note the finishing order, the number of points won and the number of laps covered.

(text modified on 1.01.00; 1.01.05).

- 1.2.121** (N) The finish line commissaire shall be provided with a raised and sheltered podium level with the finish line.

Meeting

- 1.2.122** The commissaires' panel shall meet before the start of each race. Its members shall also attend the meeting with the organiser and team managers.

Report

- 1.2.123** (N) The commissaires' panel shall draw up a detailed report on the event using the form provided for this purpose by the UCI. This report must be accompanied by the following documents:

- list of entered riders
- list of riders taking the start
- the classification(s)
- a copy of the technical guide

The timekeeper-commissaire's sheets and reports by individual commissaires shall be appended thereto. A copy of the report shall be sent to the national federation of the organiser so that the competition may be approved.

(text modified on 1.01.05).

- 1.2.124** UCI international commissaires have, furthermore, to provide a detailed report on the form provided for that purpose, giving their evaluation of the race, and to send it to the UCI in a maximum of 14 days. They must also use e-mail - or any other method specified

by the UCI - to send the complete result of the event to the UCI, at the earliest opportunity and within 2 hours at the latest.

(text modified on 1.01.04; 1.01.05).

Expenses

- 1.2.125** Commissaires shall be entitled to reimbursement of their expenses. Except in the case of international commissaires appointed by the UCI to sit on the commissaires' panel, the amounts and modes of payment shall be determined by the national federation of the organiser.

§ 3 Powers of the commissaires' panel

- 1.2.126** The commissaires' panel shall verify that the specific race regulations comply with the present regulations. It shall rectify or have rectified any provisions that do not comply and shall mention that fact during the meeting with the organiser and team managers.
- 1.2.127** The commissaires' panel shall have any irregularity it may observe in the organisation of the race rectified.
- 1.2.128** The commissaires shall note infringements and impose penalties in matters within their authority.
Each commissaire shall individually observe infringements and note them in a report bearing his signature. Commissaires' reports shall constitute conclusive evidence of the facts they observe, in the absence of proof to the contrary.

Penalties shall be imposed by the commissaires' panel by a majority vote.

- 1.2.129** Moreover each of the commissaires shall be individually entitled to take the following measures:
1. to refuse to allow riders to start who do not comply with the regulations or who are manifestly not in any condition to participate in the race;
 2. to give warnings and to inflict an admonition;
 3. to immediately remove from the competition a rider who commits a serious fault, who is manifestly not in any condition to continue the competition, who has dropped so far behind as not to be able to catch up again or who constitutes a danger to other persons.

Such decisions shall be set down in a signed report.

(text modified on 1.01.00; 1.01.05).

- 1.2.130** The commissaires' panel or, if necessary, each individual commissaire, shall take all decisions that may be required to ensure the proper conduct of the race. Those decisions shall be taken in keeping with the applicable provisions of the regulations and, to the extent of the possible, after consulting the race administration.

In the event of any non-compliance that cannot be rectified in good time, the start of the event may be delayed or cancelled or the event may be stopped. The Commissaires' Panel may withdraw if necessary, either at its own initiative or upon the instruction of the UCI.

(text modified on 1.02.11).

1.2.131 Licence holders who do not follow the instructions of commissaires shall be penalised by a suspension of between one day and six months and/or by a fine of CHF 100 to 10,000.

1.2.132 Without prejudice to article 12.1.012 on disciplinary matters, no appeal shall be admitted against observations of fact, assessments of the situation in races and application of the competition regulations by the commissaires' panel or, where appropriate, an individual commissaire, or against any other decision taken by them.

(text modified on 1.01.00; 1.01.05).

Section 5: UCI cups, series and classification

1.2.133 Is omitted from any UCI classification as well as from any UCI cups and series classifications:

1. the suspended rider. However, in case of suspension until the last event counting for the ranking, the rider is immediately excluded from the classification.
2. the rider who may have committed an anti-doping rule violation and whose identity has been publicly disclosed under article 14.4 of the UCI Anti-Doping Rules - until his definitive acquittal.

The omission means that the name of the rider does not appear in the classifications and that his place is left vacant.

(text modified on 1.09.05; 19.09.06; 1.10.09; 1.07.17).

1.2.134 The rider found guilty of an anti-doping violation is excluded from each classification which is calculated over a period in which the violation occurred.

(article introduced on 1.09.05).

Chapter III EQUIPMENT

(sections 1 and 2 introduced on 1.01.00).

Section 1: general provisions

§ 1 Principles

1.3.001 Each licence holder shall ensure that his equipment (bicycle with accessories and other devices fitted, headgear, clothing, etc.) does not, by virtue of its quality, materials or design, constitute any danger to himself or to others.

1.3.001 bis Each licence holder shall ensure that the equipment he uses on the occasion of road, track or cyclo-cross events shall be approved by the UCI according to the specifications of the Approval Protocols in force and available on the UCI Website.

(article introduced on 1.01.11).

1.3.002 The UCI shall not be liable for any consequences deriving from the choice of the equipment used by licence holders, nor for any defects it may have or its non-compliance. Equipment used must meet applicable official quality and safety standards.

A licence holder is not authorised to modify, in any way, the equipment given by the manufacturer used in competition.

(text modified on 1.04.07; 1.10.11).

1.3.003 In no event shall the fact that a rider has been able to take part in the competition give rise to liability on the part of the UCI; checks on equipment that may be carried out by the commissaires or by an agent or a body of the UCI being limited to compliance with purely sporting and technical requirements. Where required, checks on equipment and material may be carried out, before, during or after the race, at the request of the president of the commissaires' panel, or that of an agent or body of the UCI.

For that purpose, the commissaire and the UCI can seize equipment for a subsequent check, if necessary before, during or after the race, irrespective of whether the equipment was used during the competition.

If the seized equipment is found not to comply with the requirements of the UCI Regulations, the UCI may retain such item of equipment until the conclusion of any related disciplinary proceedings.

1.3.003 bis Evading, refusing or failing to allow or enable a commissaire or other competent body to conduct an equipment check shall be sanctioned as follows:

Rider or other team member: suspension of between one month and one year and/or a fine of between CHF 1'000.- and CHF 100'000.-

Team: suspension of between one and six months and/or a fine of between CHF 5'000 and CHF 100'000.

(text modified on 1.01.05; 1.07.10; 1.10.11; 6.02.17).

§ 2 Technical innovations

- 1.3.004** Except in mountain bike racing, no technical innovation regarding anything used, worn or carried by any rider or license holder during a competition (bicycles, equipment mounted on them, accessories, helmets, clothing, means of communication, etc.) may be used until approved by the UCI. Requests for approval shall be submitted to the UCI, accompanied by all necessary documentation.

Participation to the examination costs is to be paid by the applicant and is determined by the UCI Management Committee according to the complexity of the submitted technical innovation.

At Material Commission's instigation, the UCI executive bureau studies the admissibility of the technical innovation from a sporting point of view and answers within 6 months from the submission date. The innovation comes into force as from the acceptance date.

There is no technical innovation in the sense of the present article if the innovation entirely falls within the specifications foreseen in the regulations.

(text modified on 1.01.02; 1.01.04; 1.01.05; 1.02.11).

- 1.3.005** If at the start of a competition or stage the commissaires' panel considers that a rider arrives with a technical innovation or an equipment not yet accepted by the UCI, it shall refuse to permit the rider to start with such an innovation.

In the event of use in competition, the rider shall automatically be expelled from the competition or disqualified. There shall be no right to appeal against the decision of the commissaire's panel.

If this technical innovation or the equipment not yet accepted by the UCI are not noticed or sanctioned by the commissaire's panel, the UCI disciplinary commission shall order the disqualification.

The UCI shall refer to the disciplinary commission, either automatically or at the request of all interested. The disciplinary commission will only apply sanctions after having received the opinion of the equipment commission.

In out of competition situations, the UCI shall decide whether an item should be considered a technical innovation and whether the procedure provided for in article 1.3.004 is to be followed.

(text modified on 1.01.05; 1.02.12).

Section 2: bicycles

Preamble

Bicycles shall comply with the spirit and principle of cycling as a sport. The spirit presupposes that cyclists will compete in competitions on an equal footing. The principle asserts the primacy of man over machine.

§ 1 Principles

Definition

- 1.3.006** The bicycle is a vehicle with two wheels of equal diameter. The front wheel shall be steerable; the rear wheel shall be driven through a system comprising pedals and a chain.

Type

- 1.3.007** Bicycles and their accessories shall be of a type that is sold for use by anyone practising cycling as a sport.
Any equipment in development phase and not yet available for sale (prototype) must be subject of an authorization request to the UCI Equipment Unit before its use. Authorization will be granted only for equipment which is in the final stage of development and for which commercialization will take place no later than 12 months after the first use in competition. The manufacturer may request a single prolongation of the prototype status if justified by relevant reasons.

The UCI Equipment Unit will pay particular attention to the safety of the equipment which will be submitted to it for authorization.

The use of equipment designed especially for the attainment of a particular performance (record or other) shall be not authorized.

(text modified on 1.11.10; 1.10.11; 1.01.17).

Position

- 1.3.008** The rider shall normally assume a sitting position on the bicycle. This position requires that the only points of support are the following: the feet on the pedals, the hands on the handlebars and the seat on the saddle.

(text modified on 1.01.09).

Steering

- 1.3.009** The bicycle should have handlebars which allow it to be ridden and manoeuvred in any circumstances and in complete safety.

Propulsion

- 1.3.010** The bicycle shall be propelled solely, through a chainset, by the legs (inferior muscular chain) moving in a circular movement, without electric or other assistance.

In para-cycling, mechanical prostheses/orthopaedic braces for upper or lower limbs can only be used by athletes who have been evaluated in accordance with the UCI classification procedure and who have Review (R) or Confirmed (C) status.

In no case may a mechanical prosthesis/orthopaedic brace for the lower limbs be used outside paracycling events.

(text modified on 1.01.05; 1.10.13).

§ 2 Technical specifications

Except where stated to the contrary, the following technical specifications shall apply to bicycles used in road, track and cyclo-cross racing.

The specific characteristics of bicycles used in mountain bike, BMX, BMX Freestyle, trials, indoor cycling and paracycling for riders with disabilities are set out in the part regulating the discipline in question.

(text modified on 1.01.05; 25.06.07; 1.01.17).

a) Measurements (see diagram «Measurements (1)»)

1.3.011

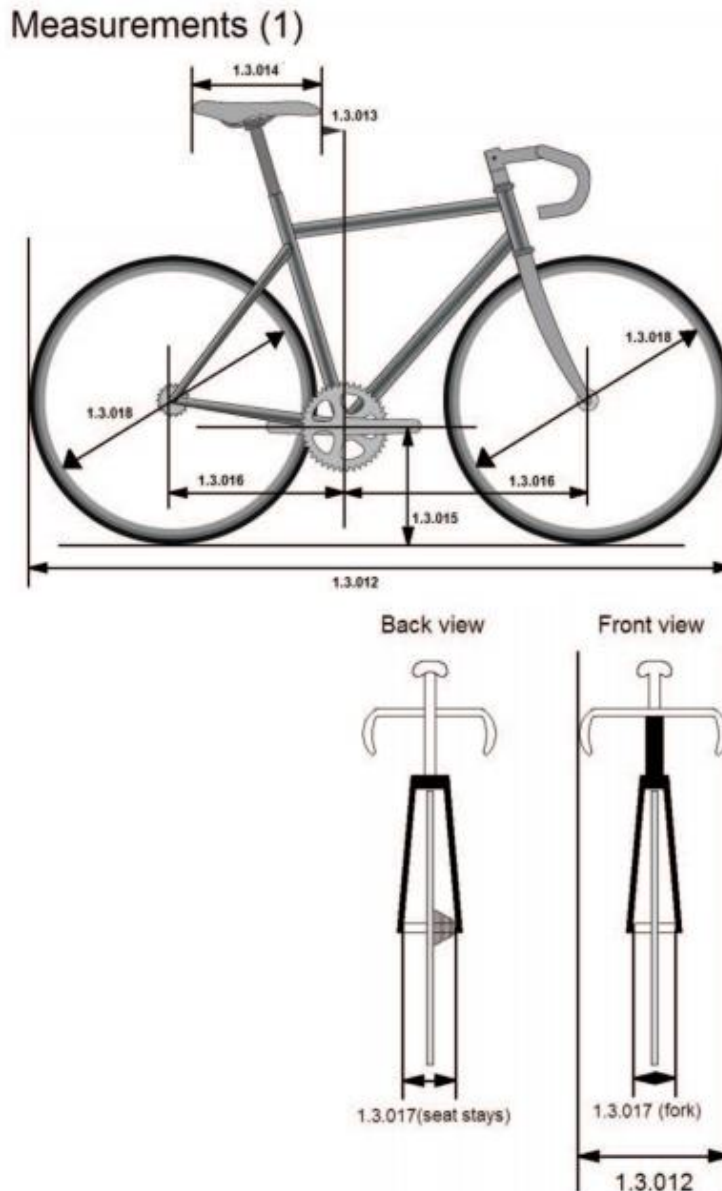

1.3.012 A bicycle shall not measure more than 185 cm in length and 50 cm in width overall.

A tandem shall not measure more than 270 cm in length and 50 cm in width overall.

- 1.3.013** The peak of the saddle shall be a minimum of 5 cm to the rear of a vertical plane passing through the bottom bracket spindle. This restriction shall not be applied to the bicycle ridden by a rider in a sprint event on track (flying 200 m, flying lap, sprint, team sprint, keirin, 500 metres and 1 kilometre); however, in no circumstances shall the peak of the saddle extend in front of a vertical line passing through the bottom bracket spindle. The peak of the saddle can be move forward until the vertical line passing through the bottom bracket spindle where that is necessary for morphological reasons. By morphological reasons should be understood everything to do with the size and limb length of the rider.

Any rider who, for these reasons, considers that he needs to use a bicycle of lesser dimensions than those given shall inform the commissaires' panel to that effect at the time of the bike check.

Only one exemption for morphological reasons may be requested; either the peak of the saddle can be moved forward or the handlebar extensions can be moved forward, in accordance with Article 1.3.023.

Measurements (2)



(text modified on 1.10.10; 1.02.12; 1.10.12).

- 1.3.014** The plane passing through the highest points at the front and rear of the saddle can have a maximum angle of nine degrees from horizontal. The length of the saddle shall be 24 cm minimum and 30 cm maximum. A tolerance of 5mm is allowed.

(text modified on 1.01.03; 1.02.12; 1.12.15).

- 1.3.015** The distance between the bottom bracket spindle and the ground shall be between 24 cm minimum and maximum 30 cm.

- 1.3.016** The distance between the vertical passing through the bottom bracket spindle and the front wheel spindle shall be between 54 cm minimum and 65 cm maximum ⁽¹⁾.

The distance between the vertical passing through the bottom bracket spindle and the rear wheel spindle shall be between 35 cm minimum and maximum 50 cm.

- 1.3.017** The distance between the internal extremities of the front forks shall not exceed 11,5 cm; the distance between the internal extremities of the rear triangle shall not exceed 14,5 cm.

(text modified on 1.01.16)

- 1.3.018** Wheels of the bicycle may vary in diameter between 70 cm maximum and 55 cm minimum, including the tyre. For the cyclo-cross bicycle the width of the tyre (measured between the widest parts) shall not exceed 33 mm and it may not incorporate any form of spike or stud.

For massed start competitions in the disciplines road and cyclo-cross, only wheel designs granted prior approval by the UCI may be used. Wheels shall have at least 12 spokes; spokes can be round, flattened or oval, as far as no dimension of their sections exceeds 10 mm.

In order to be granted approval wheels must have been subjected to the Vertical Drop Test which consists of:

Test method: Vertical Drop Test

Vertical drop test (neutralization of the rebound of the anvil)

Energy level:

40 Joules

Impact striker geometry:

Flat steel anvil, the impact surface is covered with a silicone rubber pad of 20mm thickness (Hardness Shore A=50 +/- 5, Compression set of 40% acc. To ASTM D395 Methode B). The rubber pad requires to be undamaged.

Impact mass:

Range of 6 – 10 kg

Energy must always remain at 40 Joules at the hit with a +/- 5% tolerance.

Hitting point:

- One hit at 90° from valve hole, adjusted to have the impact point of anvil between the spokes

In order to be certified as passed, the alloy and/or carbon wheels shall have

- No visible cracks or delamination
- No change in lateral profile or in lateral run out in excess of 1.0mm
- No change in radial profile or in radial run out in excess of 1.0mm

Wheels which meet the definition of traditional wheels do not need to be certified.

Definition of Traditional wheels:

Criteria:

Rim height: Less than 25 mm

Rim material: Alloy

Spokes: Minimum of 20 steel spokes which are detachable

General: All components must be identifiable and commercially available

In track competition, the use of a front disc wheel is only permitted in the specialities against the clock.

Notwithstanding this article, the choice and use of wheels remains subject to articles 1.3.001 to 1.3.003.

(text modified on 1.01.02; 1.01.03; 1.09.03; 1.01.05; 1.07.10; 1.10.13; 1.01.16).

b) Weight

1.3.019 The weight of the bicycle cannot be less than 6.8 kilograms.

c) Configuration

1.3.020 For road competitions other than time trials and for cyclo-cross competitions, the frame of the bicycle shall be of a traditional pattern, i.e. built around a main triangle. It shall be constructed of straight or tapered tubular elements (which may be round, oval, flattened, teardrop shaped or otherwise in cross-section) such that the form of each element except the chain stays and the seat stays encloses a straight line. The elements of the frame shall be laid out such that the joining points shall follow the following pattern: the top tube (1) connects the top of the head tube (2) to the top of the seat tube (4); the seat tube (from which the seat post shall extend) shall connect to the bottom bracket shell; the down tube (3) shall connect the bottom bracket shell to the bottom of the head tube. The rear triangles shall be formed by the chain stays (6), the seat stays (5) and the seat tube (4) with the seat stays anchored to the seat tube at points falling within the limits laid down for the slope of the top tube.

The maximum height of the elements shall be 8 cm and the minimum thickness 2.5 cm. The minimum thickness shall be reduced to 1 cm for the chain stays (6) and the seat stays (5). The minimum thickness of the elements of the front fork shall be 1 cm; these may be straight or curved (7). (See diagram «Shape (1)»).

The top tube may slope, provided that this element fits within a horizontal template defined by a maximum height of 16 cm and a minimum thickness of 2.5 cm.

The effective width of the head tube zone may not exceed 16 cm at the narrowest point between the inner join of the top tube and down tube and the front of the box for the head tube.

(text modified on 7.06.00; 1.01.05; 1.02.12; 1.01.16).

Shape (1)



Tubes 1, 2, 3, 4 : 2,5cm minimum & 8cm maximum
 Tubes 5, 6, 7 : 1cm minimum & 8cm maximum

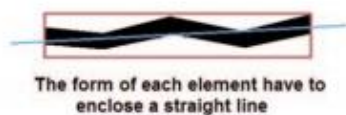
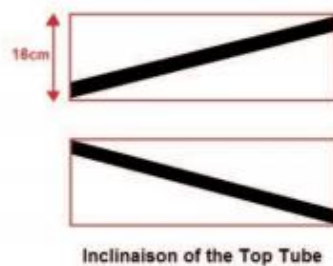
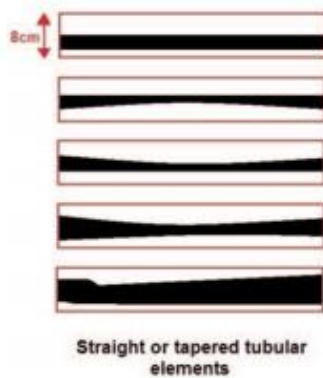

1.3.021 For road time trials and for track competitions:

- the elements of the bicycle frame may be tubular or solid, assembled or cast in a single piece in any form (including arches, cradles, beams or any other). These elements, including the bottom bracket shell, shall fit within a template of the «triangular form» defined in article 1.3.020.

(See diagram « Shape (2) »);

- isosceles compensation triangles with two 8 cm sides are authorized at the joints between frame elements except at the joints between the chain stays and seat stays where triangles are not authorised. Additionally, the compensation triangle between the top tube and down tube is replaced by a compensatory joint zone 16 cm wide delimited at its foremost by the front of the box for the head tube;
- the effective width of the head tube zone may not exceed 16 cm at the narrowest point between the inner join of the top tube and down tube and the front of the box for the head tube.

Position of boxes and compensation triangles

Shape (2)

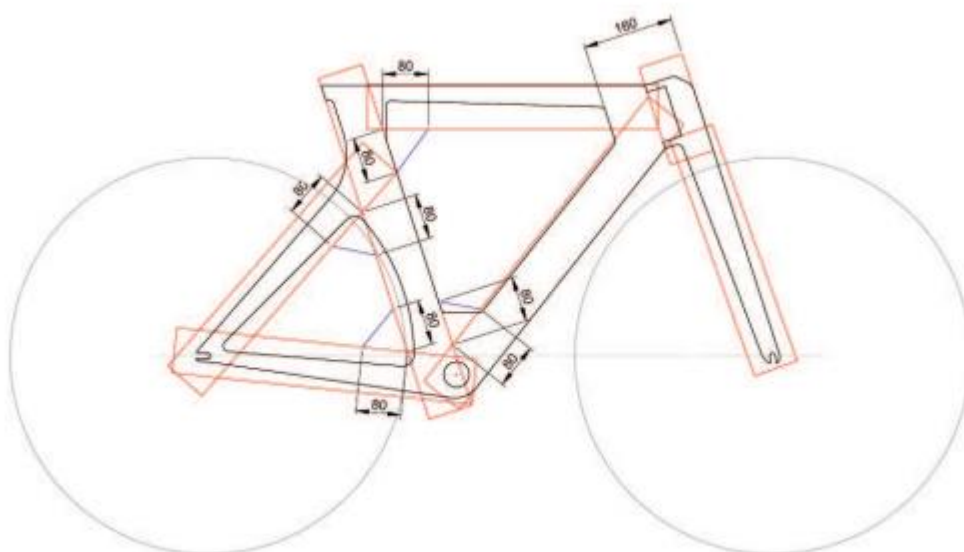

(text modified on 7.06.00; 1.01.05; 1.02.11; 1.10.12).

d) Structure

1.3.022

In competitions other than those covered by article 1.3.023, only the traditional type of handlebars (see diagram «structure 1») may be used. The handlebars must be positioned in an area defined as follows: above, by the horizontal plane of the point of support of the saddle (B); below, by the horizontal line passing 10 cm below the highest point of the two wheels (these being of equal diameter) (C); at the rear by the axis of the steerer tube (D) and at the front by a vertical line passing through the front wheel spindle with a 5 cm tolerance (see diagram «Structure (1A)»). The distance referred to in point (A) is not applicable to the bicycle of a rider who takes part in a sprint event on track (flying 200 m, flying lap, sprint, team sprint, keirin, 500 metres and 1 kilometre), but must not exceed 10 cm in relation to the vertical line passing through the front wheel spindle.

The brake controls attached to the handlebars shall consist of two supports with levers. It must be possible to operate the brakes by pulling on the levers with the hands on the lever supports. Any extension to or reconfiguration of the supports to enable an alternative use is prohibited. A combined system of brake and gear controls is authorised.

Structure (1a)

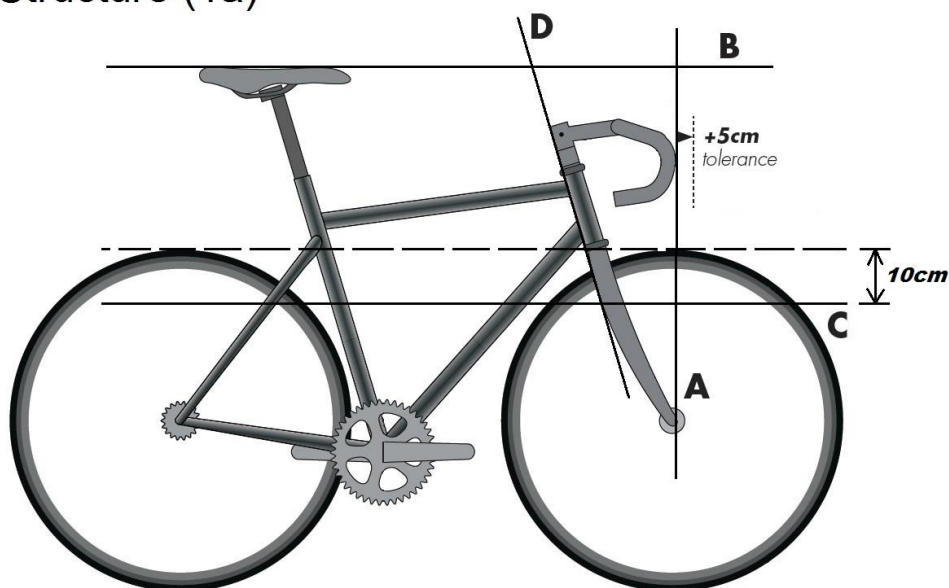

(text modified on 1.01.05; 1.02.12; 1.11.14).

- 1.3.023** For road time trials and individual and team pursuit on the track, a fixed extension may be added to the steering system; in this instance, the height difference between the elbow support points and the highest and lowest points of the handlebar extension (including gear levers) must be less than 10 cm. It is also possible to add a handlebar extension for the 500 m and kilometre time trials on the track, but in this case, the position of the tip of the saddle must be at least 5 cm behind the vertical plane passing through the bottom bracket axle.

The distance between the vertical line passing through the bottom bracket axle and the extremity of the handlebar may not exceed 75 cm, with the other limits set in article 1.3.022 (B, C, D) remaining unchanged. Elbow or forearm rests are permitted (see diagram «Structure (1B)»).

For road time trial competitions, controls or levers fixed to the handlebar extension may not extend beyond the 75 cm limit.

For the track and road competitions covered by the first paragraph, the distance of 75 cm may be increased to 80 cm to the extent that this is required for morphological reasons; «morphological reasons» should be taken as meaning anything regarding the size or length of the rider's body parts. A rider who, for this reason, considers that he needs to make use of a distance between 75 and 80 cm must inform the commissaires' panel at the time of the bike check.

For riders that are 190 cm tall or taller, the horizontal distance between the vertical lines passing through the bottom bracket axle and the extremity of the handlebar extensions including all accessories may be extended to 85 cm.

Only one exemption for morphological reasons may be requested; either the handlebar extension can be moved forward or the peak of the saddle can be moved forward, in accordance with Article 1.3.013.

Structure (1B)

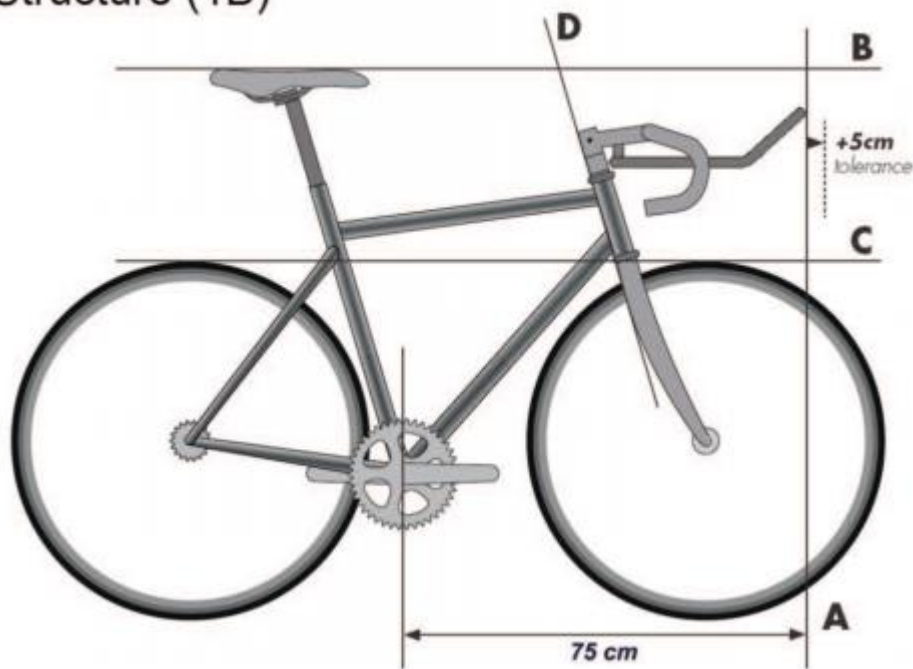

(text modified on 7.06.00; 1.01.05; 1.04.07; 1.01.09; 1.02.12; 1.10.12; 29.04.14).

- 1.3.024** Any device, added or blended into the structure, that is destined to decrease, or which has the effect of decreasing, resistance to air penetration or artificially to accelerate propulsion, such as a protective screen, fuselage form fairing or the like, shall be prohibited.

Structure (2)

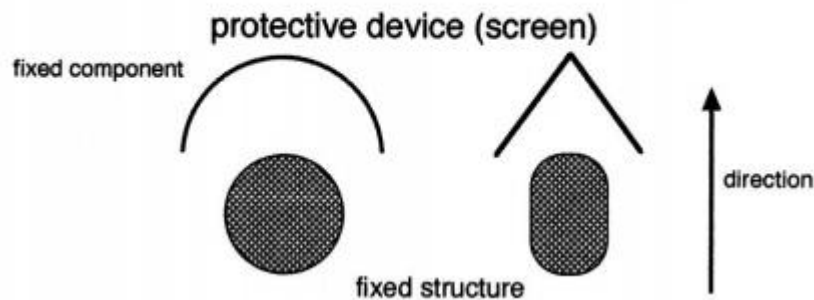

A protective screen shall be defined as a fixed component that serves as a windscreen or windbreak designed to protect another fixed element of the bicycle in order to reduce its wind resistance.

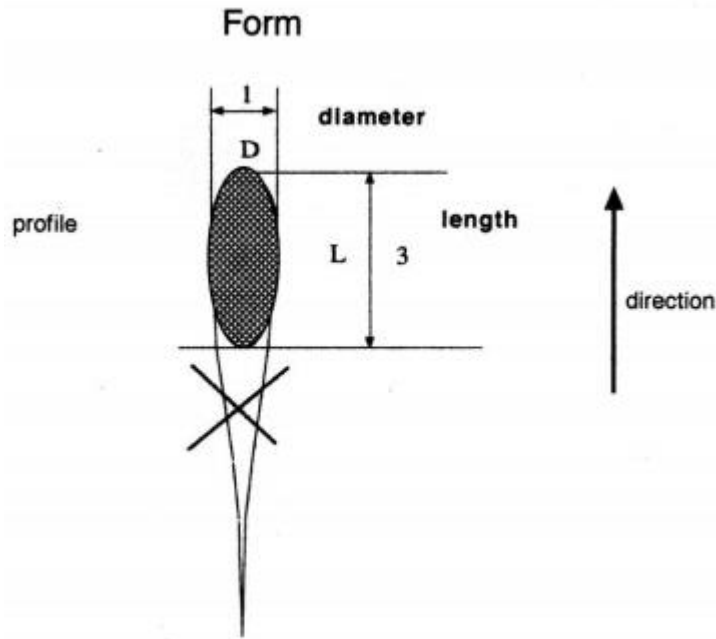

A fuselage form shall be defined as an extension or streamlining of a section. This shall be tolerated as long as the ratio between the length L and the diameter D does not exceed 3. This rule does not apply to frame and fork of the bicycle.

Structure (3)

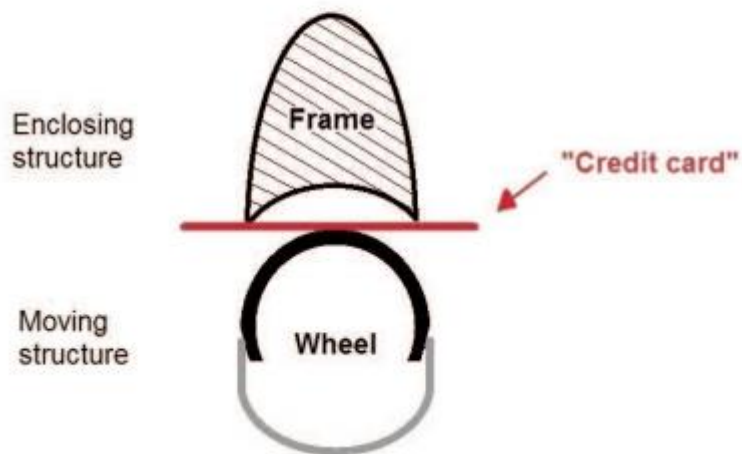

practical way of confirming the existence of fairing on a moving part such as a wheel : it should be possible to pass a rigid card (like a credit card) between the fixed structure and the moving part.

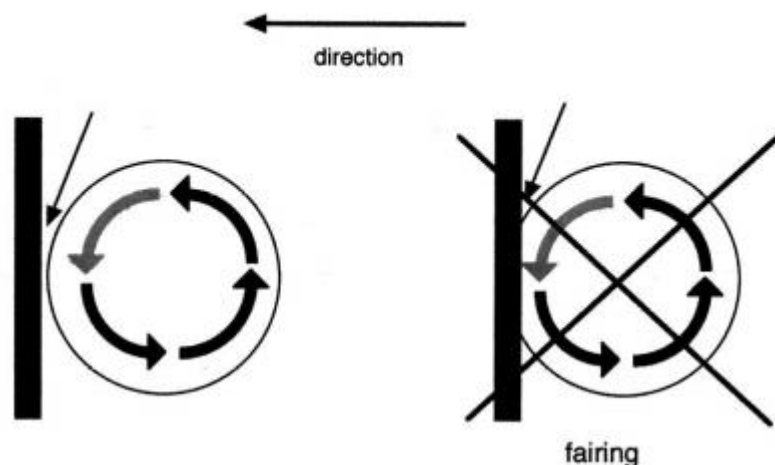

A fairing shall be defined as the use or adaptation of a component of the bicycle in such a fashion that it encloses a moving part of the bicycle such as the wheels or the chainset. Therefore, it should be possible to pass a rigid card (like a credit card) between the fixed structure and the moving part.

(text modified on 1.01.17).

- 1.3.024 bis** Bottles shall not be integrated in the frame and may only be located on the down and seat tubes on the inside of the frame and cannot be integrated to the frame. The dimensions of the cross sections of a bottle used in competition must not exceed 10 cm or be less than 4 cm and their capacity must be a minimum of 400 ml and a maximum of 800 ml.

(article introduced on 1.10.11; text modified on 1.01.13).

- 1.3.024 ter** Any bicycle may be fitted with onboard technology equipment that has the ability and purpose to collect or transmit data, information or images. Such equipment shall comprise telemetry and transponder units and video cameras. Bicycles may be fitted with such equipment under the following conditions:

- The system to install the equipment must be designed for use on bicycles and shall not affect the certification of any item of the bicycle;
- The system to install the equipment must not allow the equipment to be removed during the race and the equipment will be considered non-removable;
- The rider must not have any direct access to the images or information concerning other riders being collected or transmitted during the race.

Compliance with the aforementioned conditions and provided all other provisions of the UCI Regulations are respected, means that the use of onboard technology is authorised but does not imply that the UCI undertakes any responsibility for it. The UCI shall not be liable for any consequences deriving from the installation and use of onboard technology by licence holders, nor for any defects it may hold or its non-compliance.

This article and the requirements contained herein do not apply to removable computers / rider information systems.

Notwithstanding the above, articles 4.3.014 or 6.1.060 remain fully applicable with regard to the use of onboard technology equipment.

(article introduced on 1.01.16)

- 1.3.025** Freewheels, multiple gears and brakes are not permitted for use on the track during competition or training.
Disc brakes are allowed in cyclo-cross training and competition.
Disc brakes are allowed in mountain bike training and competition.
Disc brakes are allowed in Trials training and competition.
Disc brakes are allowed in mass participation / cycling for all events / sportives included on the respective international and national calendars
For races on the road and cyclo-cross, the use of fixed sprocket is forbidden: a braking system that acts on both wheels is required.

(text modified on 1.09.04; 1.01.05; 1.01.09, 1.07.09; 1.07.10; 27.03.17).

Section 3: riders' clothing

§ 1 General provisions

- 1.3.026** When competing, all riders shall wear a jersey with sleeves and a pair of shorts, possibly in the form of a one-piece skinsuit. By shorts it is understood that these are shorts that come above the knee.
Sleeveless jerseys shall be forbidden.

However, for downhill and 4-cross mountain bike events, BMX, trials and indoor cycling, specific provisions are laid down in the part of the regulations concerning the discipline in question.

(text modified on 1.01.02; 1.01.04; 1.01.05).

- 1.3.027** Jerseys shall be sufficiently distinct from world champions', UCI cup and classification leaders' and national jerseys to avoid confusion.
- 1.3.028** Save in cases expressly provided for in the regulations, no distinctive jersey may be awarded or worn.
- 1.3.029** No item of clothing may hide the lettering on the jersey or the rider's identification number, particularly in competition and at official ceremonies.

(text modified on 1.01.05).

- 1.3.030** Rain capes' design must be transparent or be similar to the jersey by use of one of the principal team colours. The team's name must be displayed on it.

(text modified on 1.01.00; 1.01.15).

- 1.3.031** 1. Wearing a rigid safety helmet shall be mandatory during competitions and training sessions in the following disciplines: track, mountain bike, cyclo-cross, trials and BMX, BMX Freestyle, para-cycling, as well as during cycling for all events.
2. During competitions on the road, a rigid safety helmet shall be worn.

During training on the road, the wearing of a rigid safety helmet is recommended. However, riders must always comply with the legal provisions in this regard.

3. Each rider shall be responsible for:

- ensuring that the helmet is approved in compliance with an official security standard and that the helmet can be identified as approved;
- wearing the helmet in accordance with the security regulations in order to ensure full protection, including but not limited to a correct adjustment on the head as well as a correct adjustment of the chin strap;
- avoiding any manipulation which could compromise the protective characteristics of the helmet and not wearing a helmet which has been undergone manipulation or an incident which might have compromised its protective characteristics;
- using only an approved helmet that has not suffered any accident or shock;
- using only a helmet that has not been altered or had any element added or removed in terms of design or form;
- using only accessories approved by the helmet manufacturer.

(text modified on 5.05.03; 1.01.04; 1.08.04; 1.01.05; 1.02.07; 1.07.11; 1.01.15; 1.01.17; 27.03.17).

1.3.032 [article abrogated].

1.3.033 It is forbidden to wear non-essential items of clothing or items designed to influence the performances of a rider such as reducing air resistance or modifying the body of the rider (compression, stretching, support).

Items of clothing or equipment may be considered essential where weather conditions make them appropriate for the safety or the health of the rider. In this case, the nature and texture of the clothing or equipment must be clearly and solely justified by the need to protect the rider from bad weather conditions. Discretion in this respect is left to the race commissaires.

The use of shoe covers is prohibited during events on a covered track.

Equipment (helmets, shoes, jerseys, shorts, etc.) worn by the rider may not be adapted to serve any other purpose apart from that of clothing or safety by the addition or incorporation of mechanical or electronic systems which are not approved as technical innovations under article 1.3.004.

(text modified on 1.01.02; 1.01.04; 1.04.07; 1.10.10; 1.02.12).

1.3.034 During competitions, riders' attendants may not bear any advertising matter on their clothing other than that authorised for their team's riders for the race in question.

§ 2 Teams registered with the UCI

General observations

1.3.035 Each team may have only a single design for clothing - colours and layout - which may not be altered for the duration of the calendar year.

UCI WorldTeams and UCI professional continental teams must submit for approval, before production, their clothing to UCI no later than December 1st before the year in question. Other teams shall submit for approval their clothing to the national federation of the team at the moment of the team registration no later than December 10th before the year in question.

(text modified on 1.01.00; 1.01.05; 1.10.09; 1.01.15; 3.06.16; 25.10.17).

1.3.036 Provisions for permanent change during the season

Any permanent change to clothing must be duly justified and submitted for approval to the UCI at least 30 days before the expected date of coming into effect. The UCI will provide the team with an answer no later than 15 days prior to the expected date of coming into effect.

Provisions for a temporary change during the season

Each Road team may use different clothing for one full event each year. The clothing must be submitted for approval to the UCI, at least 60 days before the start date of the event in question. The application may be rejected for reasons considered valid. The UCI will provide the team with an answer no later than 30 days prior to the start date of the event in question.

Applications either for a permanent or temporary change will be considered in the order in which they are received by the UCI.

However, these provisions do not apply to the clothing of National Champions and Continental Champions; the modifications of which are subject to approval from respectively, national federations and continental confederation.

(text modified on 1.01.00; 1.01.04; 1.01.05; 1.10.11; 1.01.15; 25.10.17).

1.3.037 Riders' clothing shall always be identical to the specimen lodged.

(text modified on 1.01.99).

Advertising matter

1.3.038 The name, company logo or trade mark of the principal partner shall be preponderant (thicker characters) and placed in the upper part of the jersey, both on the front and the back.

If there be two principal partners registered with UCI, one of them least shall appear as mentioned above.

1.3.039 The order in which the two principal partners appear on the jersey may be inverted from one race to another during the calendar year.

1.3.040 [article abrogated on 1.01.1998].

1.3.041 [article abrogated].

1.3.042 Other advertising inscriptions may be freely used and can vary from one race or country to another.

1.3.043 In all cases, the advertising matter and its layout shall be the same for all riders of a given team in the same competition.

(text modified on 1.01.00; 1.01.05).

1.3.044 In track events, by mutual agreement between the race organiser and the team, the team jersey may be replaced by a jersey devoid of advertising matter, not even bearing the name of the team itself.

In six-day races, the organiser may impose jerseys with the advertisement of his choice, while allowing the rider's sponsor to place its name in a rectangle of maximum 6 cm in height.

(text modified on 1.01.00; 1.01.05).

§ 3 Regional and club teams

General observations

1.3.045 For the events on the national calendar, the team may only use a single design of clothing (colours and arrangement) which must remain unaltered throughout the calendar year. In other respects, the matter shall be decided by the national federation of the country where the race is run.

For events on the international calendar, the rules below shall apply to riders belonging to a regional or club team, with the exception of riders who are also members of a team registered with the UCI.

(text modified on 1.01.05).

- 1.3.046** Each regional or club team for whom one or more riders take part in an event on the international calendar must, at the start of the year, notify the details of their clothing to their national federation specifying in detail the colours and their arrangement and the main sponsors.

The name of the region and/or club may appear, in full or in abbreviated form, on the jersey.

(text modified on 1.01.05).

- 1.3.047** Riders for the club shall wear uniform clothing complying exactly with that described in the notification referred to in article 1.3.046. Unless specifically provided for, no rider shall be permitted to ride in the colours of any association or company other than those of the club given on his licence.

Advertising matter

- 1.3.048** Clubs may display the names (logo or trade mark) of their commercial sponsors on their clothing by way of advertising.

A prior written agreement has to be concluded between the club and the sponsor.

- 1.3.049** The name, logo or trade mark of the sponsor(s) may be used freely on the jersey. In addition the jersey may bear other lettering which may even differ from one race or country to another, without any limitation on the number.

(text modified on 1.01.00).

- 1.3.050** [article abrogated on 1.01.05].

§ 4 Leaders' clothing

Stage races

- 1.3.051** A classification leader's jersey in stage races must be sufficiently distinct from those of the teams and clubs, as well as from national jerseys, world champions' jerseys and those of UCI cups, series and classification leaders.

Conversely, concerning road cycling and more specifically for "grands tours" only, it shall be the teams that are required to differentiate their jersey from that of the individual general classification leader's jersey.

(text modified on 1.01.05; 1.01.16).

- 1.3.052** (N) An individual general classification leader's jersey shall be mandatory.

- 1.3.053** (N) Advertising on a leader's jersey shall be reserved for the organiser of the race.

However, on the upper front and back of the jersey, in a rectangle 32 cm high and 30 cm wide, the lower 22 cm shall be reserved for use by the teams on a white background.

The horizontal upper segment of the rectangle will match the lower point of the collar. The principal partner(s) of a team shall stand out there from all other advertisements.

This provision shall also apply to the skinsuit worn by the leader; the lower part (shorts) of the skinsuit shall be reserved for team advertising within a 9 cm wide horizontal band on each leg.

(text modified on 1.01.00; 1.01.05; 1.01.16).

- 1.3.054** The wearer of the leader's jersey shall be entitled to match the colour of his shorts to that of the jersey.

(text modified on 1.01.99).

- 1.3.055** In time trial stages, leaders may wear the aerodynamic jersey or skinsuit of their teams if the organiser does not provide an aerodynamic leader's jersey or skinsuit.

(text modified on 1.01.05).

UCI cups, series and classifications

- 1.3.055 bis** 1. The designs of the leader's jerseys for UCI cups, series and classifications are determined by the UCI and are their exclusive property. They may not be reproduced without UCI authorisation.

They may not be altered, except as regards the advertising space reserved for the wearer's team.

2. Advertising on the leader's jerseys of UCI cups, series and classifications is reserved for the UCI.

However, on the upper front and back of the jersey, in a rectangle 32 cm high and 30 cm wide, the lower 22 cm shall be reserved for use by the teams on a white background. The principal partner(s) of a team shall stand out there from all other advertisements.

This provision shall also apply to the skinsuit worn by the leader; the lower part (shorts) of the skinsuit shall be reserved for team advertising within a 9 cm wide horizontal band on each leg.

3. The wearer of the leader's jersey shall be entitled to match the colour of his shorts to that of the jersey.

4. In time trial stages, leaders may wear the aerodynamic jersey or skinsuit of their teams if the UCI does not provide an aerodynamic leader's jersey or skinsuit.

(text modified on 1.01.05; 1.09.05; 1.01.06; 1.01.09; 1.07.17).

§ 5 National team clothing

- 1.3.056** National federations shall submit to the commissaires' panel of events as specified in art. 1.3.059, a sample of their national team clothing for validation. The design, color, place and size of the advertising spaces of the validated equipment must be identical for all athletes participating to the applicable events.

We encourage you to present to the UCI your national apparels before sending them for final production.

The apparel of the riders of a national team must always be identical to the last sample submitted.

(text modified on 17.07.98; 1.01.04; 25.06.07).

1.3.057 The following advertising shall be authorised:

- front of the jersey: 2 rectangular zones of 80 cm² maximum;
- rear of the jersey: rectangular strip maximum 20cm high;
- area comprising shoulders and sleeves: strip of maximum 9 cm high;
- on the sides of the jersey: a 9 cm wide strip;
- sides of the shorts: a 9 cm wide strip;
- rear of the shorts: rectangular strip of 10cm high;
- the manufacturer's label (30 cm²) may appear once only on the jersey and once on each leg of the shorts.

Advertising matter, as detailed above, shall be used at the national federation's discretion.

Advertising matter on jersey and shorts may vary from one rider to another.

The design of the jersey and shorts may vary from one category of rider to another.

Advertising on protective leggings worn for downhill mountain bike, trials and BMX events is not subject to the advertising restrictions on shorts.

Additionally, the rider's name may appear on the back of the jersey.

The above measures also apply to other items of clothing worn during competition (rain jackets, etc.).

(text modified on 1.01.00; 1.01.03; 1.01.04; 1.01.05; 8.02.18).

1.3.058 The advertising spaces shall be reserved for the use of the national federation except in the following cases:

A. track world cup

for riders belonging to a team registered with the UCI, the advertising spaces are reserved for the team, except for a rectangular zone of 64 cm² on the front of the jersey which is reserved for the national federation.

B. cyclo-cross world cup

If the rider has one or more sponsors, a rectangle of height 10 cm and width 30 cm on the front and rear of the jersey shall in the first instance be reserved for their use. In this case these rectangles comprise the only advertising spaces available on these parts of the jersey. If and only if there is no advertising for a rider's sponsors, the national federation may make use of two rectangular zones of 64 cm² on the front of the jersey.

Riders who belong to a trade team or club can wear the jersey of their trade team or club, as long as they notify the National Federation of this when they apply for selection. Otherwise the National Federation may require the wearing of the national jersey. The national jersey is compulsory for the U23 and Junior National teams.

C. BMX world and continental championships and challenges

If the rider has one or more sponsors, a rectangle of height 10 cm on the front of the jersey shall be reserved for their use. In this case these rectangles comprise the only advertising spaces available on these parts of the jersey. If and only if there is no

advertising for a rider's sponsors, the national federation may make use of two rectangular zones of 64 cm² on the front of the jersey. The other advertising spaces on the jersey (shoulder and sleeve strip, sides) are reserved in the first instance for the national federation.

Each rider having received a UCI permanent number (as outlined in § 10, Title 6 of the UCI regulations), must print his number on the jersey according to the following principles:

- a) The colour of the number must be in strong contrast with the colour of the background.
- b) The distance between the digits must be 1.5 cm
- c) The minimum height of the number must be 20 centimeters
- d) The width of the numbers shall be:
 - minimum 10 cm for one digit numbers
 - minimum 20 cm for two digit numbers
 - minimum 25 cm for three digit numbers
- e) There should be a minimum of 5 cm of free space without publicity around the number.
- f) As an option, he must display his last name across the shoulders, above the number.

(text modified on 17.07.98; 1.01.05; 14.10.08; 19.06.09).

- 1.3.059** The wearing of national team clothing shall be mandatory:
- at world championships
 - at continental championships
 - for the riders of a national team
 - during Olympic and Paralympic Games, in accordance with the IOC and NOC Regulations.

The continental and national champions must comply with this rule and wear their national team clothing while participating in the events cited here before.

(text modified on 1.01.98; 1.01.04; 1.01.05; 1.01.06; 1.10.10; 26.07.17).

§ 6 World champion's jersey

- 1.3.060** The right to the «rainbow colours» is the exclusive property of the UCI. Any commercial use of the rainbow colours is strictly prohibited.

(text modified on 1.10.10).

- 1.3.061** The design, including colours and layout, of each world champion's jersey according to category and/or discipline, as well as the distinctive logo of the UCI Team Time Trial World Champions, are the exclusive property of the UCI. The jersey, and the distinctive logo for the UCI Team Time Trial World Champions, may not be reproduced without UCI authorisation. The design may in no way be modified.

(text modified on 1.10.10; 1.07.12).

- 1.3.062** [article abrogated on 1.01.05].

1.3.063 Until the day before the world championship of the following year, the world champions must wear their jersey in all events in the discipline, speciality and category in which they won their title, and in no other event.

The world champion team of the UCI Team Time Trial shall wear the distinctive logo on their jerseys in all road events from 1 January until 31 December in the year following the World Championship event.

The world champion in the individual time trial is not authorised to wear the world champion's jersey during team time trial events.

In six-day races, only madison world champions may wear the jersey, even if they are not paired together.

In para-cycling, for Tandem (B), Team Relay (TR) and Team Sprint (TS), only world champion athletes must wear the rainbow jerseys even if the pair or the team subsequently dissolve.

The world champion jersey, or the distinctive logo for the UCI Team Time Trial World Champions, must be worn at every opportunity with public exposure, in particular during competitions, awards ceremonies, press conferences, television interviews, autograph sessions, photo sessions and other occasions.

(text modified on 1.01.05; 1.01.06; 1.10.10; 1.07.12; 1.10.13).

1.3.064 Without prejudice to paragraph 2 below, only the current world champion rider may wear rainbow piping on his equipment (such as bike, helmet, shoes) as per the technical specifications in the brochure which will be sent to him by the UCI. However, he may use the equipment bearing the rainbow piping only in events of the discipline, speciality and category in which he won the title and in no other event.

The current individual time trial world champion is authorised to use rainbow stripes on their time trial bicycle for individual time trial and team time trial events.

When he no longer holds the title of world champion, a rider may wear rainbow piping on the collar and cuffs of his jersey, to the exclusion of any other equipment, as per the technical specifications in the brochure which will be sent to him by the UCI. However, he may wear such a jersey only in events of the discipline, speciality and category in which he won the title and in no other event. In compliance with the provisions 1.3.056 and 1.3.059, he is not authorized to add the rainbow piping on his national team clothing. Any equipment bearing the rainbow piping shall be submitted to UCI for approval before production.

(text modified on 1.01.05; 1.09.05; 24.09.07; 1.10.10; 1.01.15).

1.3.065 [article abrogated on 1.07.17]

1.3.066 The world champion's jersey awarded at the official ceremony may carry no advertising matter other than that determined by the UCI.

1.3.067 The world champion shall be entitled to have advertising matter placed on his jersey from the day following the official ceremony until the day before the next world championships.

The exact location of advertising space is defined in the brochure provided by the UCI to each national federation of which a rider becomes world champion.

The wearer of the world champion's jersey shall be entitled to match the colour of his shorts to that of the jersey.

(text modified on 1.01.01; 1.10.10).

§ 7 National champion's jersey

- 1.3.068** National road, track, cyclo-cross, mountain bike, BMX, trials and indoor cycling champions must wear their jersey in all events in the discipline, speciality and category in which they won their title and no other event.

The national champion in the individual time trial is not authorised to wear the distinctive national champion's jersey during team time trial events.

In a six-day event, only madison national champions must wear the jersey even if they are not paired together.

(N) When he no longer holds the title of national champion, a rider can wear piping in national colours on the collar and cuffs of his jersey and shorts as per the technical specifications determined by the national federation. However, he can wear such a jersey only in events of the discipline, speciality and category in which he won the title and in no other event.

The national champion jersey must be worn whenever a rider is engaged in activities on the track, awards ceremonies, press conferences, television interviews, autograph sessions and other occasions which require a good presentation.

(text modified on 1.01.99; 1.01.04; 1.01.05; 1.01.06; 1.10.10; 1.01.13; 1.01.15; 1.07.17).

- 1.3.069** The specificities concerning the design of the national champion jersey are described in the brochure available on the UCI website. These specificities are applicable for all the disciplines.

Before production, the national champion jersey design (colours, flag, drawing) reproduced by the titled rider must be approved by the concerned national federation and must respect the latter's dispositions.

Each national federation must have its national champion jersey design registered by the UCI, for each discipline, at least 21 days before the national championships of the discipline in question.

The wearer of a national champion's jersey shall be entitled to match the colour of his shorts to that of the jersey.

However, under the prior approval of the concerned National Federation and instead of wearing a traditional national champions jersey in the sense of the provision 1.3.068, the national champions in MTB DHI, MTB 4X and BMX have the possibility to wear a distinct national champion jersey with the left arm sleeve representing the flag of the rider's country. No advertising is authorized on that left arm sleeve of the national champion jersey. Apart from the left arm sleeve and without prejudice to the provisions 1.3.026 to 1.3.044, the remaining spaces (e.g. front, back and right arm sleeve) are let at the

disposal of the riders for their usual sponsors. The specificities are described in the brochure available on the UCI website.

(text modified on 1.01.01; 1.01.04; 1.10.10; 1.07.11).

§ 8 Continental champion's jersey

- 1.3.070** If a jersey is awarded at a continental championship, the rider may wear it in all races in the discipline, speciality and category in which he won the title and for as long as he continues to hold the title.

Continental confederations may impose the mandatory wearing of their continental champion's jersey in the discipline, specialty and category of their choosing.

The authorised advertising spaces shall be identical to those on the world champion's jersey.

Before production, the continental champion jersey design (colours, flag, drawing) reproduced by the titled rider must be approved by the concerned continental confederation and must respect the latter's dispositions.

(text modified on 1.01.04; 1.01.05; 1.09.05; 1.01.16; 1.07.17).

§ 9 Order of priority

- 1.3.071** Without prejudice to relevant provisions but applicable for all the disciplines, should various provisions requiring the wearing of different jerseys apply to the same rider, the order of priority shall be as follows:

1. the leader's jerseys of the stage race
2. the world champion's jersey
3. the leader's jersey of the cup, series or UCI classification
4. the continental champion's jersey
5. the national champion's jersey
6. the national jersey

(text modified on 26.08.04; 1.01.05; 1.01.06, 1.02.07; 1.09.08; 1.01.09; 1.10.09; 1.10.10; 1.10.13; 1.01.15; 1.01.17; 26.07.17)

§ 10 Sanctions

- 1.3.072** The following infringements shall be penalised as indicated below:
(the sums are the fine in CHF)

1. Non-regulation clothing (colour and layout)
 - rider: 50 to 200 and start not permitted
 - team: 250 to 500 per rider
2. Non-regulation advertising
 - 2.1 Team, per rider bearing non-regulation advertising:
 - jersey: 500 to 2,100 and start of the rider concerned not permitted
 - shorts: 300 to 1,050 and start of the rider concerned not permitted

- skinsuit: 700 to 3,000 and start of the rider concerned not permitted
- 2.2 Leader's jersey
 - organiser: 1,000 to 2,100 per rider concerned and rider not obliged to wear the jersey
 - team: 1,000 to 2,100 per rider concerned and start of the riders concerned not permitted
- 3. Leader's jersey
 - 3.1 Unavailability of jerseys or skinsuits as required by the race regulations
 - organiser: 1,000 to 2,100 per rider concerned
 - 3.2 Leader's jersey or skinsuit not fit to wear
 - organiser: 1,000 to 2,100 per rider concerned
 - 3.3 Allocation of unauthorised jerseys
 - organiser: 1,000 to 2,100 per jersey concerned
- 4. Rider not wearing:
 - world champion's jersey: team: 2,500 to 5,000 and start of the rider concerned not permitted
 - leader's jersey of a UCI cup, circuit, series or classification:
 - team: 2,500 to 5,000 and start of the rider concerned not permitted
 - rider: start not permitted and loss of 50 points in the UCI classification concerned
 - national champion's jersey: team: 2,500 to 5,000
 - national clothing: team: 500 to 1,000 per rider and start of the riders concerned not permitted
- 5. National team clothing:
 - failure to submit to the UCI (article 1.3.056): national federation: 500 to 10,000
- 6. World champion's equipment:
 - in breach of article 1.3.066 or 1.3.067: rider: 2,000 to 100,000
 - wearing of the jersey in a discipline, speciality or category other than that in which it was won: rider: 2,000 to 10,000
 - in breach of article 1.3.065: rider: 200 to 10,000
 - in breach of article 1.3.064: rider 2,000 to 10,000
 - logo of UCI Team Time Trial World Champions not worn: team: 10,000
- 7. National champion's jersey:
 - in breach of article 1.3.068, second paragraph: rider: 200 to 10,000.

The amounts of the fines set above are doubled in the event of an offence during a world championship.

(text modified on 1.03.01; 1.01.04; 1.01.05; 1.10.10; 1.07.11; 1.07.12).

Section 4: identification of riders

Identification number

1.3.073 During competitions, the following provisions shall be made for the identification of riders.

Discipline/speciality	Body number	Frame number	Shoulder number*	Handlebar number
Road				
One-day races	2	1		
Stage races	2	1		
Time trials	1			
Cyclo-cross	1		2	
Track				
Sprint	2			
Individual pursuit	1			
Team pursuit	1			
1 km TT	1			
500 m TT	1			
Points race	2			
Keirin	2			
Team sprint	1			
Madison	2			
Omnium (all events)	2			
BMX		2 (lateral)**		1
Mountain bike (all events)	1			1
Trials	1			1

* The shoulder numbers shall be worn on the upper forearm so it's visible frontally.

** Frame numbers shall be used in BMX only if required as stated in the event technical guide.

(text modified on 1.01.01; 1.01.04; 1.01.05; 1.09.05; 1.01.06; 1.02.11; 1.02.12; 05.02.15).

1.3.074 Unless otherwise stipulated the number panels and plates shall bear black characters on a white background.

1.3.075 The characters, panels and plates shall be of the following dimensions:

	Body number	Frame number & Helmet stickers for handcycle	Shoulder number	Handlebar number
Height	18 cm	9 cm	9 cm	18 cm MTB 20 cm BMX 11 cm Trials
Width	16 cm	13 cm	7 cm	18 cm MTB 25 cm BMX 16 cm Trials
Digits	10 cm	6 cm	5 cm	8 cm MTB 10 cm BMX 10 cm Trials
Line width	1,5 cm	0,8 cm	0,8 cm	1.5 cm MTB 1.5 cm BMX 1.5 cm Trials
Advertising	height 6 cm on the lower part	rectangle of 11x2 cm on the lower or upper part	height 1.5 cm on the lower and upper part	- MTB height 4 cm on the upper and lower part - BMX 6 cm on the upper part - Trials 2.5 cm on the lower part

(text modified on 1.01.01; 1.01.04; 1.10.09; 1.01.11; 13.03.15; 1.07.17).

1.3.076 Riders shall ensure that their identification number is visible and legible at all times. The identification number shall be well fixed and may not be folded or altered.

(text modified on 1.01.05).

1.3.077 The identification numbers provided by the organiser shall be used by riders without any kind of alteration. They shall be issued free of charge by the organiser, after the rider's licence has been checked by the commissaires' panel.

(text modified on 1.01.05; 1.01.17).

1.3.078 At World Championships, the identification numbers shall be provided by the UCI. The advertising space shall be reserved for the UCI.

(text modified on 1.01.05).

1.3.079 [article abrogated on 1.01.05].

1.3.080 Any rider dropping out of the race shall immediately remove his identification number.

(text modified on 1.01.05).